

AQHA Show Weikersdorf April 2018

013 Showmanship Nov. Amateur AQHA

Show Date: 04-20-2018

w w w . H o r s e S h o w P a t t e r n s . c o m

w w w . H o r s e S h o w P a t t e r n s . c o m

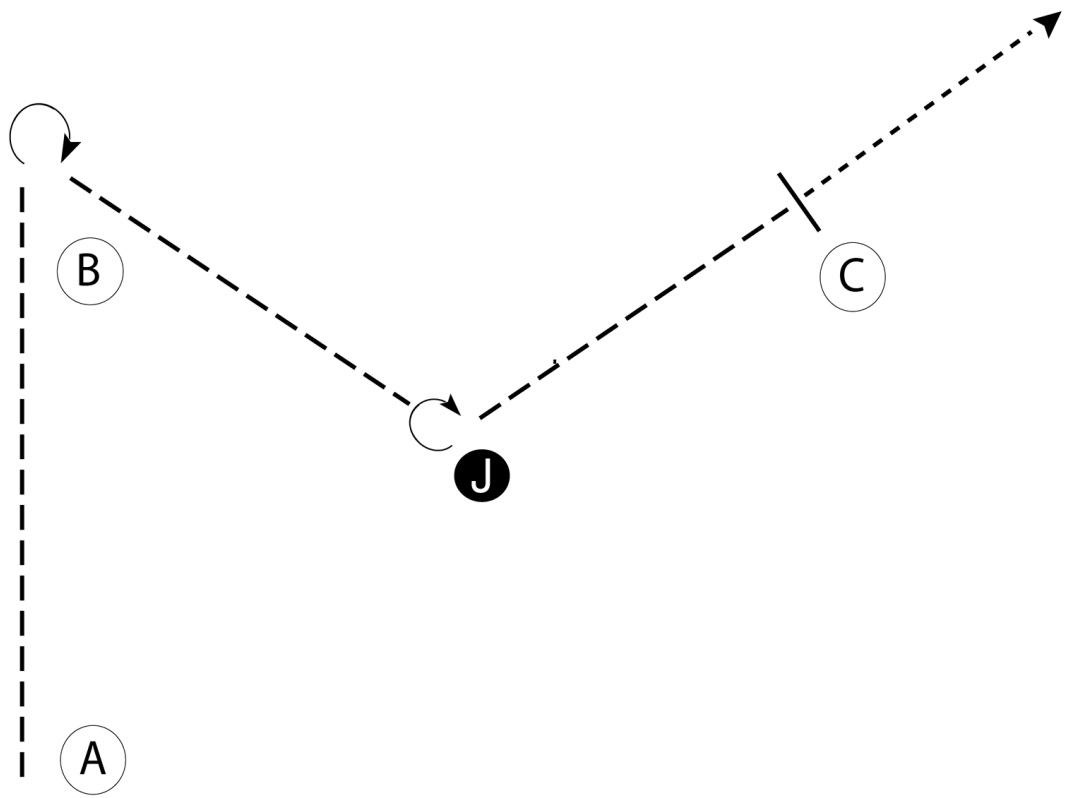

Be ready at A.

1. Trot to and past B.
2. Stop past B, turn 135 degrees and trot to judge.
3. Stop and set up for inspection.
4. When dismissed, do a 3/4 turn and trot to C.
5. Stop at C. When dismissed, walk straight away from C to exit.

| | |
|--------|-----------|
| Walk | ----- |
| Trot | - - - - - |
| Back | ← |
| Marker | ⓑ |
| Judge | ⓙ |

[S/1-24]

Pattern Provided by:

P.V. Performance Horses

AQHA Show Weikersdorf April 2018

062 Horsemanship Youth LZF

Show Date: 04-20-2018

w w w . H o r s e S h o w P a t t e r n s . c o m

w w w . H o r s e S h o w P a t t e r n s . c o m

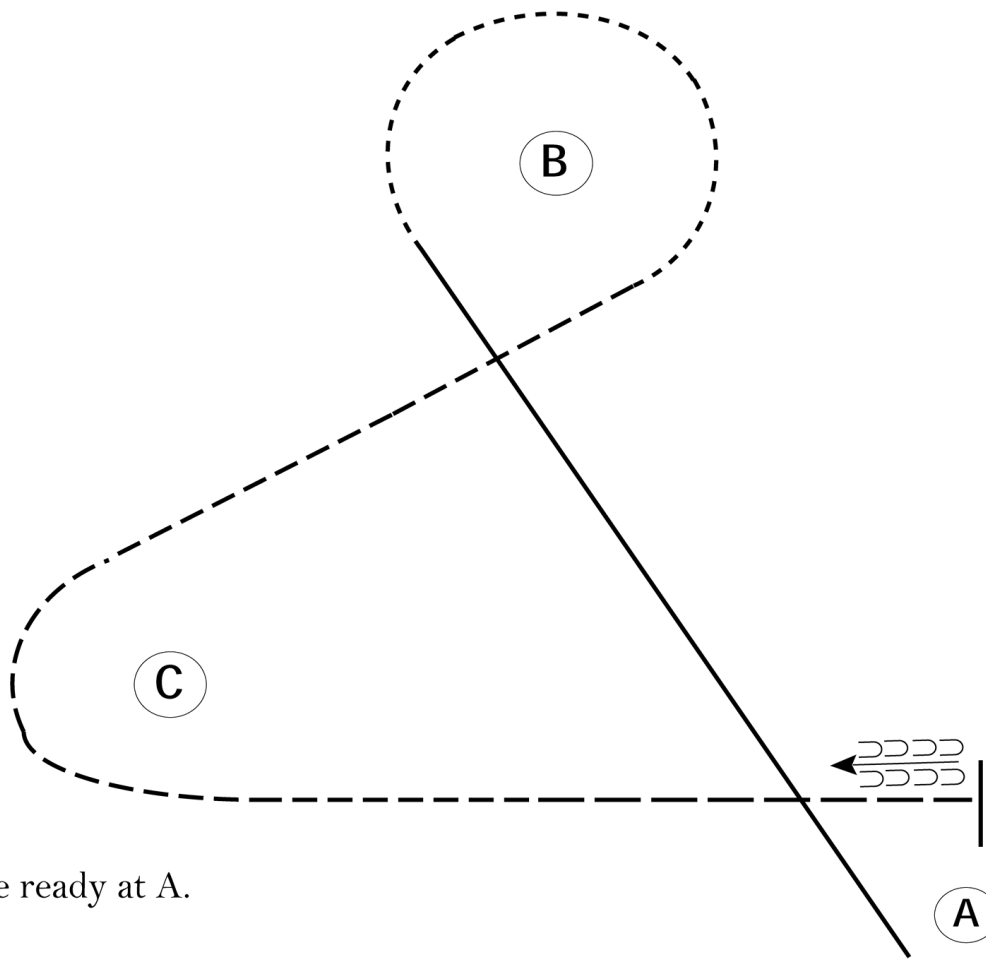

Be ready at A.

1. Lope on the left lead to B.
2. At B, break to the walk and walk around B.
3. Jog from B to and around C.
4. Halfway to A, extend the jog to A.
5. At A, stop and back approximately one horse length.

Follow the instructions of the ring steward.

| | |
|---------------------|-------------|
| Walk | ----- |
| Jog | - - - - - |
| Extended Jog | - - - - - |
| Lope | ————— |
| Leg Yield | |
| Lead Change | — / — |
| Back | ← ← ← ← ← |
| Marker | ⊙ B |
| Sidepass | ← — — — — → |

[WH/1-55]

Pattern Provided by:
P.V. Performance Horses

AQHA Show Weikersdorf April 2018

108 Horsemanship Youth LZF

Show Date: 04-20-2018

w w w . H o r s e S h o w P a t t e r n s . c o m

w w w . H o r s e S h o w P a t t e r n s . c o m

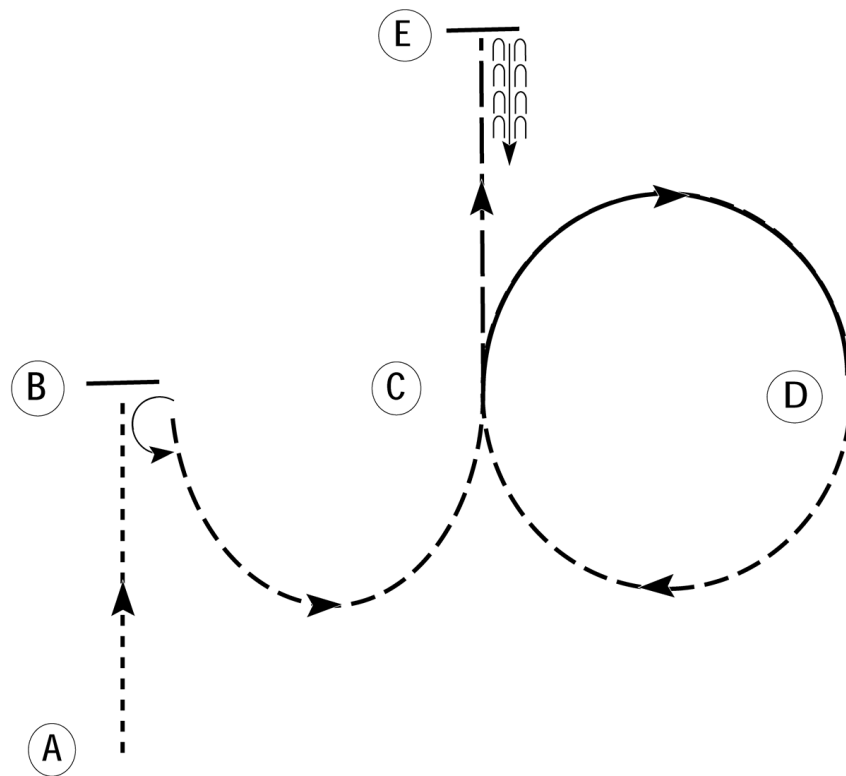

Be ready at A.

1. Walk to B.
2. Stop at B and turn 180 degrees to the left.
3. Jog to C..
4. Lope on the right lead to D.
5. Jog to C.
6. Extend the jog to E.
7. Stop and back approximately one horse length.

Follow the instructions of your ring steward.

| | |
|---------------------|-----------|
| Walk | ----- |
| Jog | - - - - - |
| Extended Jog | - - - - - |
| Lope | ————— |
| Leg Yield | |
| Lead Change | — / — |
| Back | ← ← ← ← ← |
| Marker | Ⓚ |
| Sidepass | ← ← ← ← ← |

[WH/1-61]

Pattern Provided by:
P.V. Performance Horses

AQHA Show Weikersdorf April 2018

109 Horsemanship Nov. Amateur AQHA

Show Date: 04-20-2018

w w w . H o r s e S h o w P a t t e r n s . c o m

w w w . H o r s e S h o w P a t t e r n s . c o m

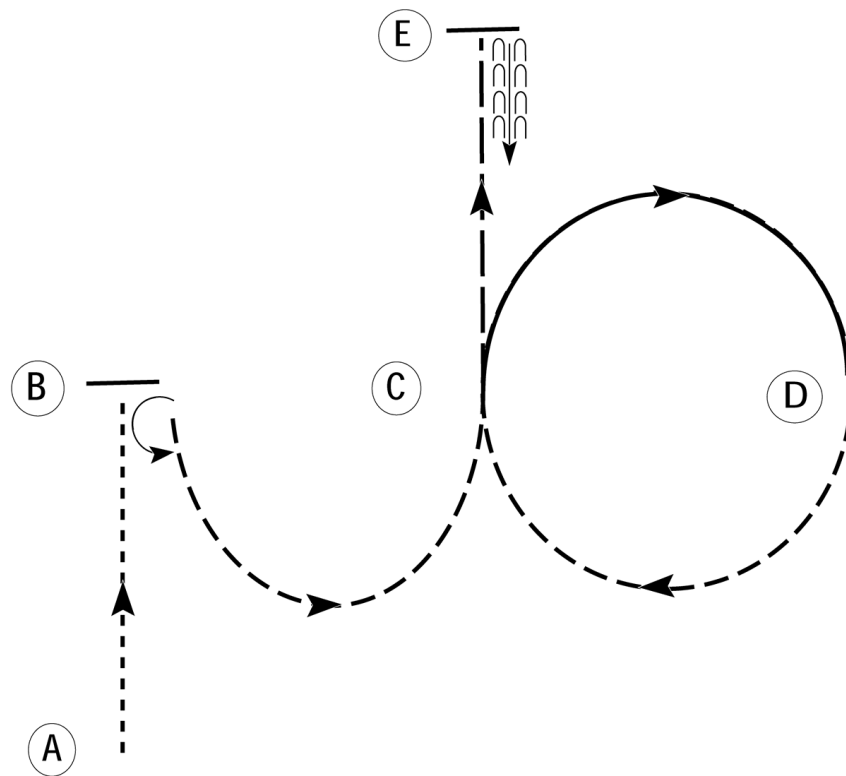

Be ready at A.

1. Walk to B.
2. Stop at B and turn 180 degrees to the left.
3. Jog to C..
4. Lope on the right lead to D.
5. Jog to C.
6. Extend the jog to E.
7. Stop and back approximately one horse length.

Follow the instructions of your ring steward.

| | |
|---------------------|----------------|
| Walk | ----- |
| Jog | - - - - - |
| Extended Jog | - - - - - |
| Lope | ————— |
| Leg Yield | |
| Lead Change | — / — |
| Back | ←←←←← ←←←←← |
| Marker | Ⓚ |
| Sidepass | ←-----→ |

[WH/1-61]

Pattern Provided by:
P.V. Performance Horses

AQHA Show Weikersdorf April 2018

060 Horsemanship Amateur AQHA

Show Date: 04-20-2018

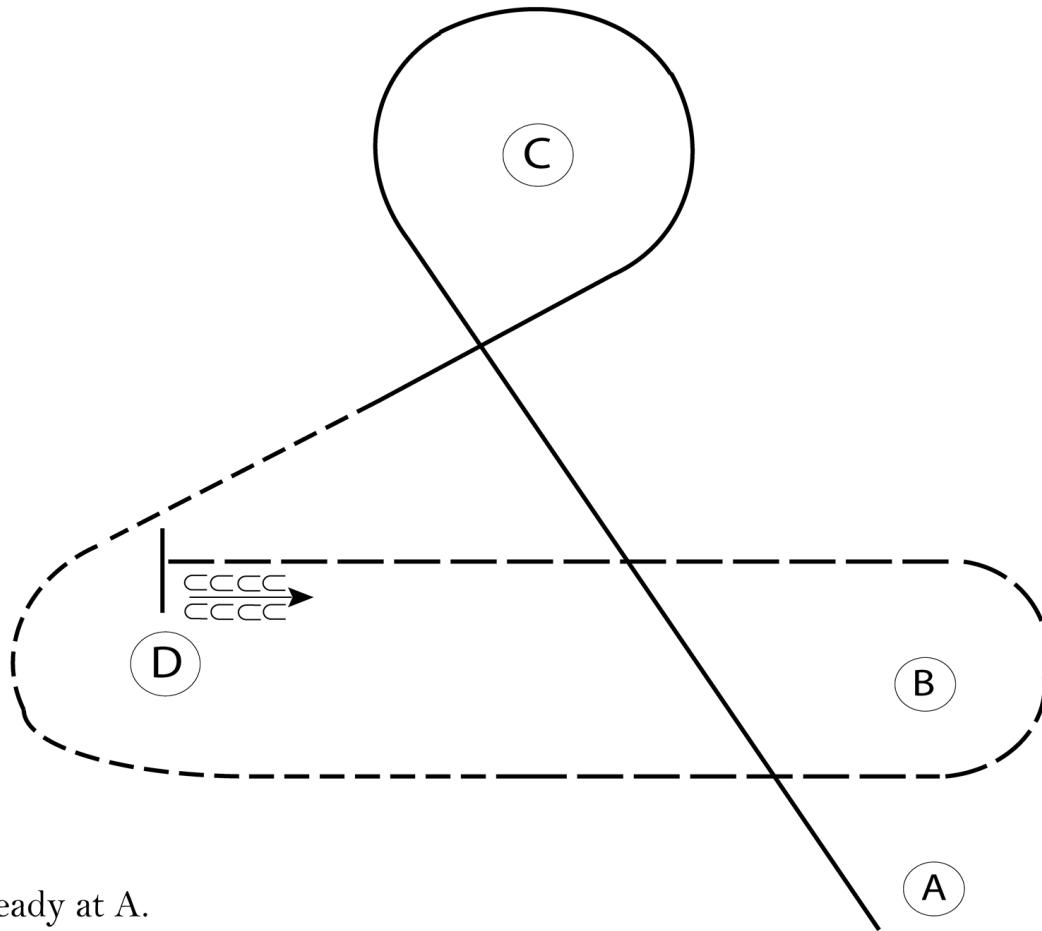

Be ready at A.

1. Right lead lope to and around C
2. Halfway to D break to the jog
3. Jog around D
4. Halfway to B extend the jog
5. Continue extended jog around B to D
6. At D stop and back approximately one horse length.

Follow the instructions of your ring steward.

| | |
|--------------|-----------|
| Walk | ----- |
| Jog | - - - - - |
| Extended Jog | - - - - - |
| Lope | ————— |
| Leg Yield | |
| Lead Change | — / — |
| Back | ← ← ← ← ← |
| Marker | Ⓟ |
| Sidepass | ← ——— → |

[WH/2-54]

Pattern Provided by:

P.V. Performance Horses

w w w . H o r s e S h o w P a t t e r n s . c o m

w w w . H o r s e S h o w P a t t e r n s . c o m

AQHA Show Weikersdorf April 2018

111 Horsemanship Youth AQHA

Show Date: 04-20-2018

w w w . H o r s e S h o w P a t t e r n s . c o m

w w w . H o r s e S h o w P a t t e r n s . c o m

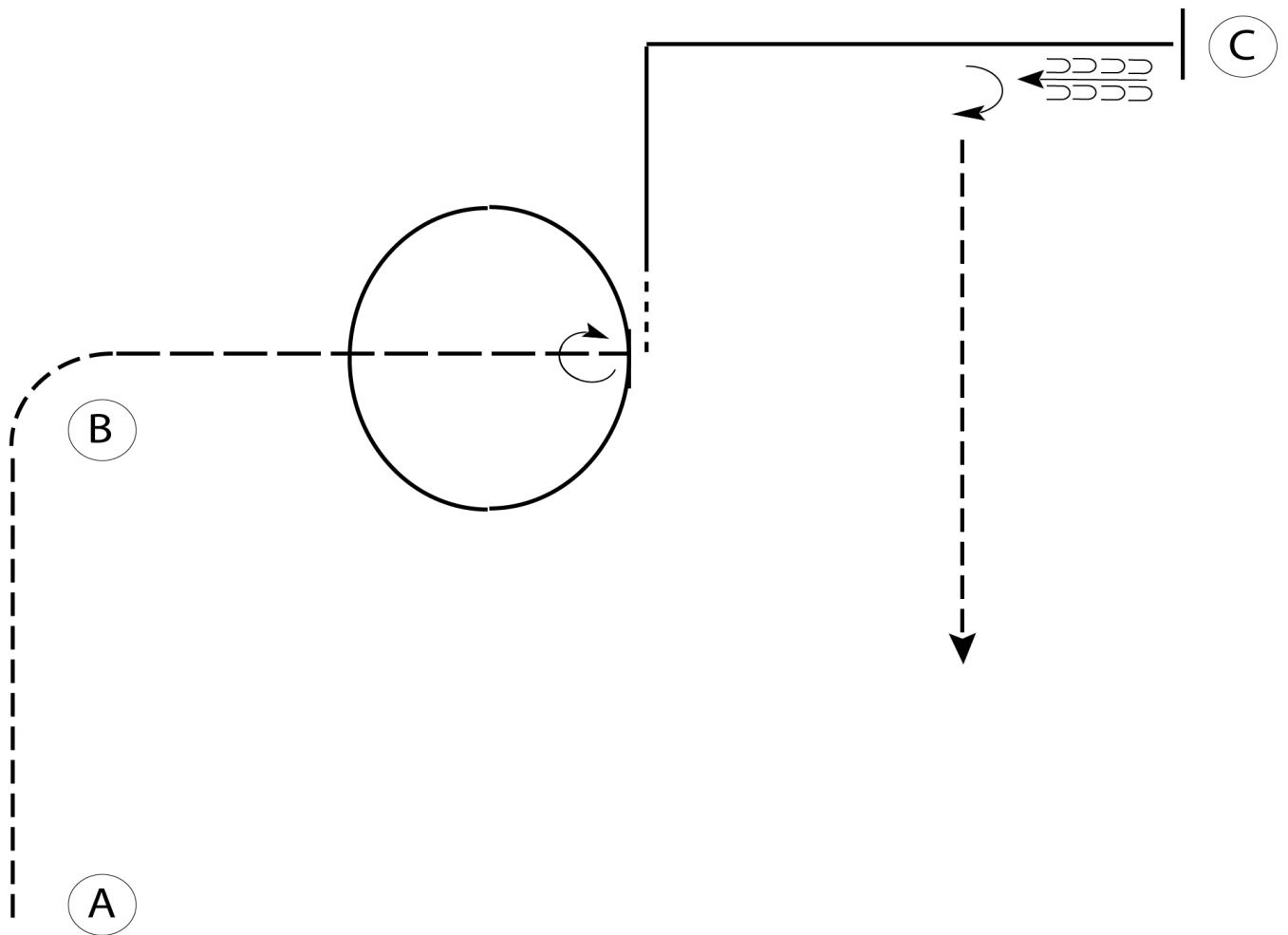

Be ready at A.

1. Jog to and around B.
2. Extend the jog to the middle of your pattern.
3. Perform a 3/4 turn right.
4. Perform a small left lead lope circle.
5. Break to a walk and walk approximately 2 horse lengths.
6. Lope on the right lead and lope a square corner to C.
7. Stop and back.
8. Perform a 1/4 turn right.
9. Jog to exit.

| | |
|---------------------|------------|
| Walk | ----- |
| Jog | - - - - - |
| Extended Jog | — — — — |
| Lope | ————— |
| Lead Change | |
| Back | |
| Marker | (B) |

[WH/2-107]

Pattern Provided by:

P.V. Performance Horses

AQHA Show Weikersdorf April 2018

061 Horsemanship Rookie LZ

Show Date: 04-20-2018

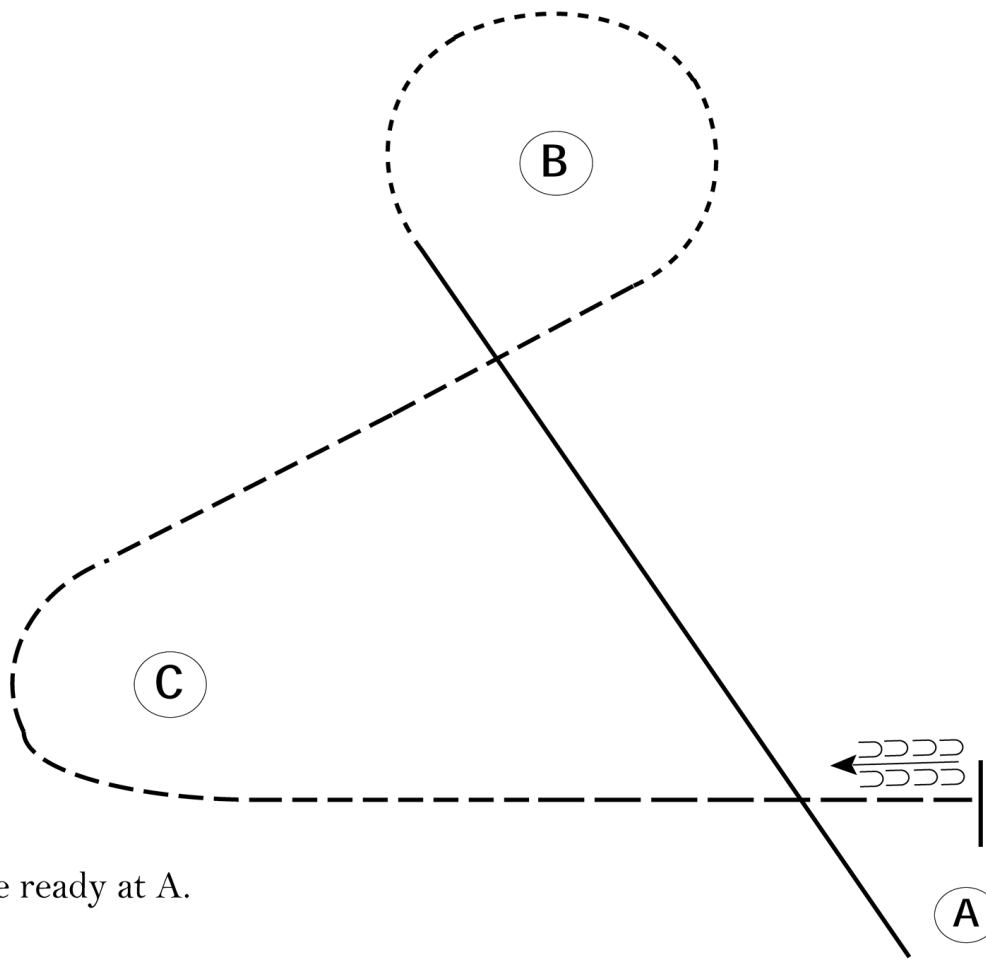

Be ready at A.

1. Lope on the left lead to B.
2. At B, break to the walk and walk around B.
3. Jog from B to and around C.
4. Halfway to A, extend the jog to A.
5. At A, stop and back approximately one horse length.

Follow the instructions of the ring steward.

| | |
|--------------|------------------------|
| Walk | ----- |
| Jog | - - - - - |
| Extended Jog | - - - - - |
| Lope | ————— |
| Leg Yield | |
| Lead Change | — / — |
| Back | ← — — — — — — — — — |
| Marker | ⊙ B |
| Sidepass | ← — — — — → |

[WH/1-55]

Pattern Provided by:

P.V. Performance Horses

w w w . H o r s e S h o w P a t t e r n s . c o m

w w w . H o r s e S h o w P a t t e r n s . c o m

AQHA Show Weikersdorf April 2018

014 Amateur AQHA Showmanship

Show Date: 04-20-2018

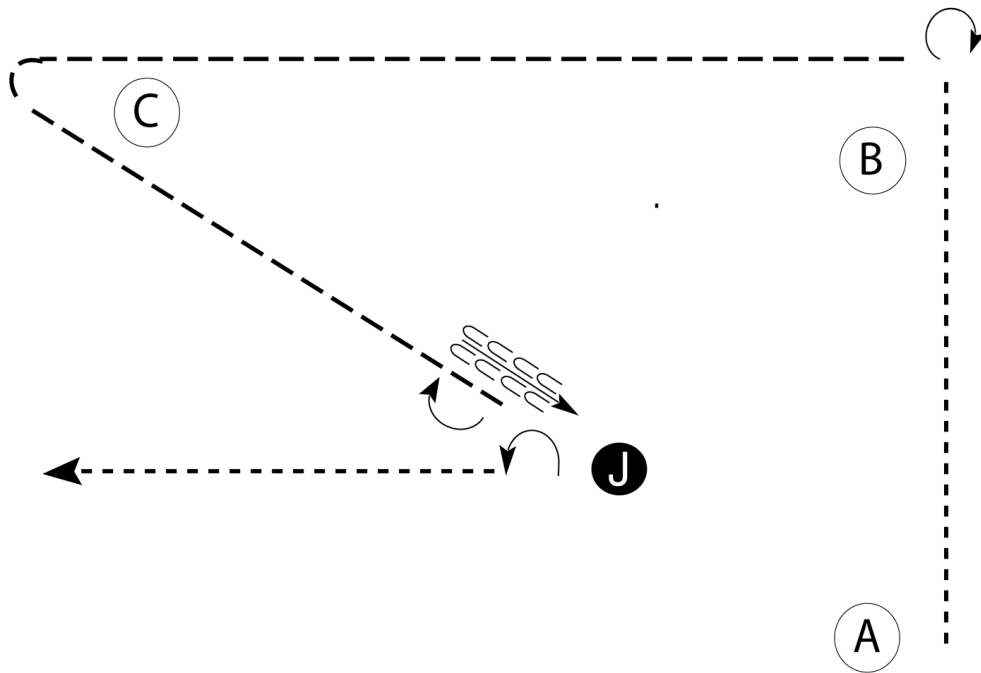

Be ready at A.

1. Walk to and past B.
2. Turn 270 degrees.
3. Trot to and around C.
4. When 2 horse lengths from the judge, stop.
5. Turn 180 degrees.
6. Back to judge and set up for inspection.
7. When dismissed, perform a 90 degree pull turn (left) and exit at a walk.

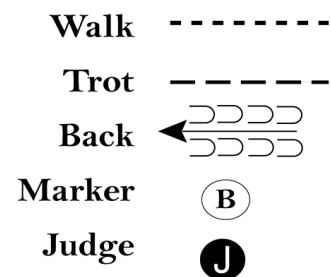

[S/3-25]

Pattern Provided by:

P.V. Performance Horses

AQHA Show Weikersdorf April 2018

053 Showmanship Youth Aqha

Show Date: 04-20-2018

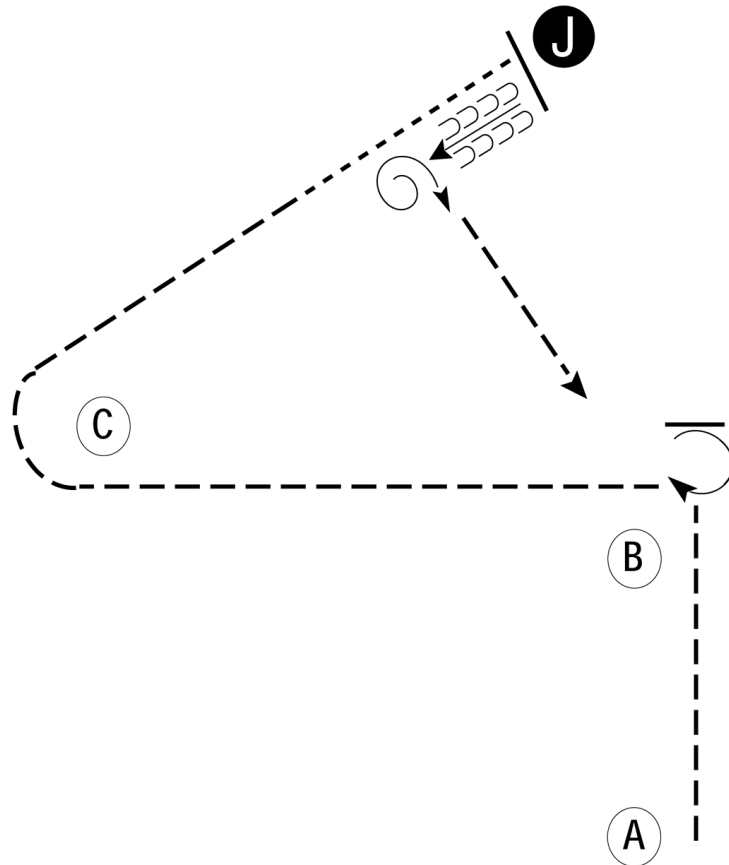

Be ready at A.

1. Trot from A past B.
2. Stop and perform 270 degree turn.
3. Trot around C. Break to a walk half way to the Judge.
4. Walk to Judge, stop and set up for inspection.
5. When dismissed back one horse length.
6. Perform a 450 degree turn and trot to the line-up or follow the instructions of your ring steward.

| | |
|--------|-----------|
| Walk | ----- |
| Trot | - - - - - |
| Back | ← ← ← ← ← |
| Marker | (B) |
| Judge | (J) |

[S/3-14]

Pattern Provided by:

P.V. Performance Horses