

CWN-C ZNS/ARHA WTC Western Star Cup 1
 Wr. Neustadt/NÖ * 07.04. - 09.04.2023
 01 Trail Rookie

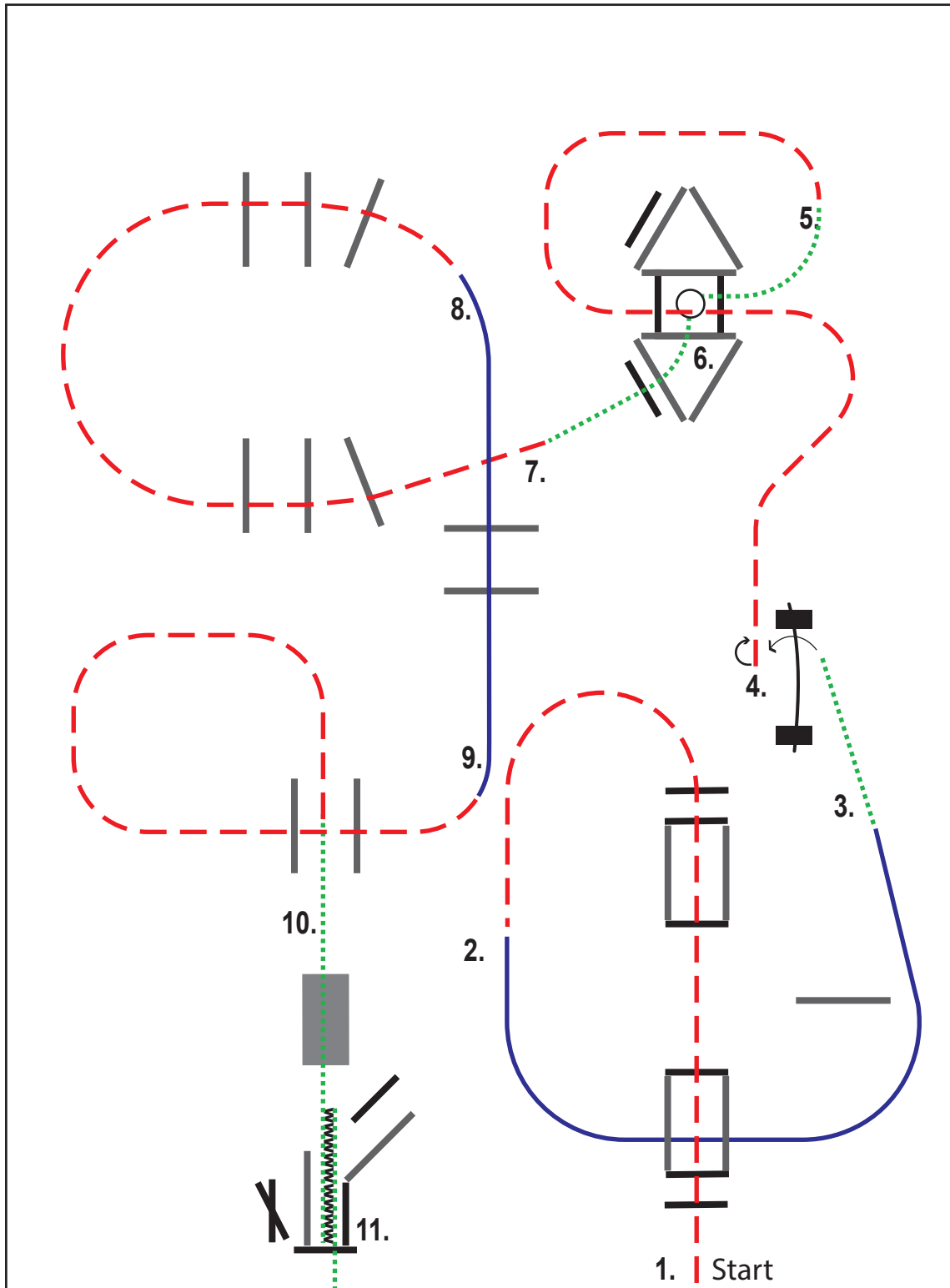

- 1. jog over poles
- 2. lope over poles left lead
- 3. walk to gate, gate left hand
- 4. turn 180° right, jog over poles
- 5. walk into box, turn 45° left
- 6. walk over poles

- 7. jog over poles
- 8. lope over poles right lead
- 9. jog over poles
- 10. walk over bridge
- 11. back up, walk out

- Schritt
- - - - - Trab
- Galopp
- MMM Rückwärts
- ↔ Seitwärts
- Pylonen
- X Erhöhungen
- ⌋ Tor



designed by Nina Zwölfer

CWN-C ZNS/ARHA WTC Western Star Cup 1
 Wr. Neustadt/NÖ * 07.04. - 09.04.2023
 02 Trail Junior Open

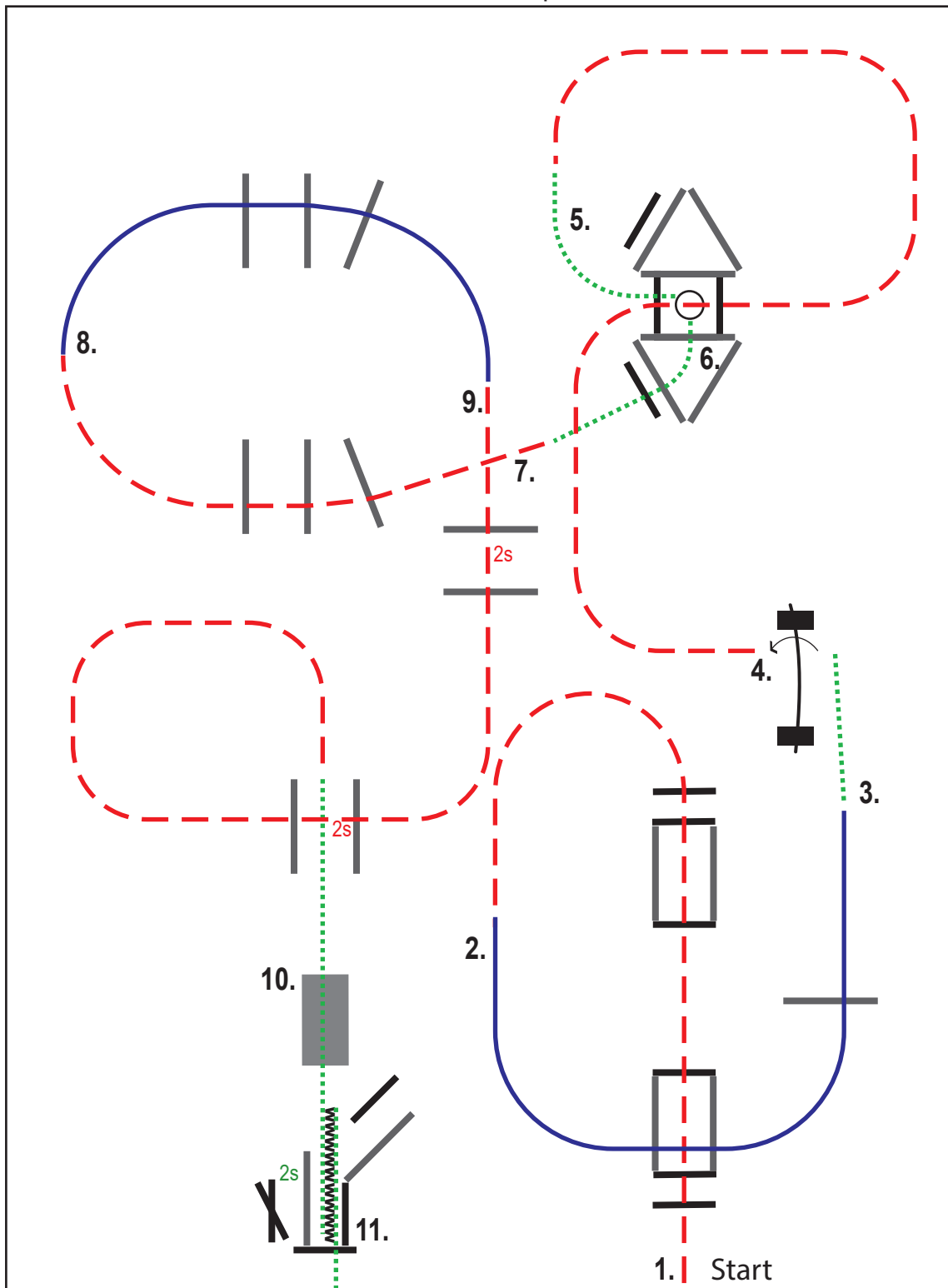

- | | |
|----------------------------------|---------------------------------|
| 1. jog over poles | 7. jog over poles |
| 2. lope over poles left lead | 8. lope over poles right lead |
| 3. walk to gate, gate left hand | 9. jog over poles |
| 4. jog over poles | 10. walk over bridge into chute |
| 5. walk into box, turn 270° left | 11. back up, walk out over pole |
| 6. walk over poles | |

- | | |
|----------------|--------------|
| Schritt | ↔ Seitwärts |
| - - - - - Trab | ○ Pylonen |
| ———— Galopp | X Erhöhungen |
| MMM Rückwärts | ⌋ Tor |



designed by Nina Zwölfer

CWN-C ZNS/ARHA WTC Western Star Cup 1
 Wr. Neustadt/NÖ * 07.04. - 09.04.2023
 03 Trail Amateur

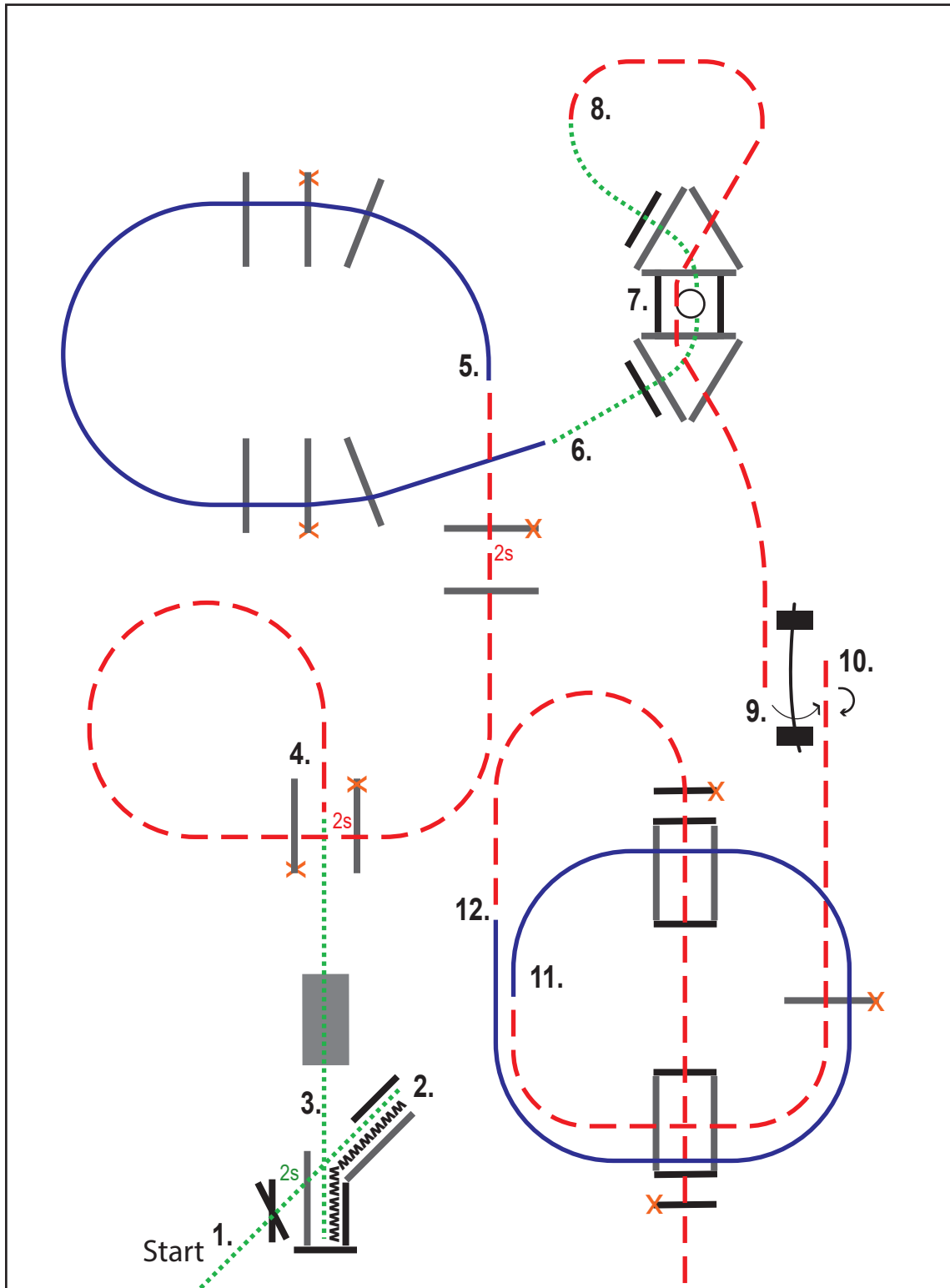

1. walk over cross and pole into chute
2. back up
3. walk over bridge
4. jog over poles
5. lope over poles left lead
6. walk over poles

7. turn 360° either way
8. jog over poles
9. gate left hand, turn 180° right
10. jog over poles
11. lope over poles right lead
12. jog over poles

- | | |
|----------------|--------------|
| Schritt | ↔ Seitwärts |
| - - - - - Trab | ○ Pylonen |
| ———— Galopp | X Erhöhungen |
| MMM Rückwärts | ⌋ Tor |



designed by Nina Zwölfer

CWN-C ZNS/ARHA WTC Western Star Cup 1
 Wr. Neustadt/NÖ * 07.04. - 09.04.2023
 04 Trail Open

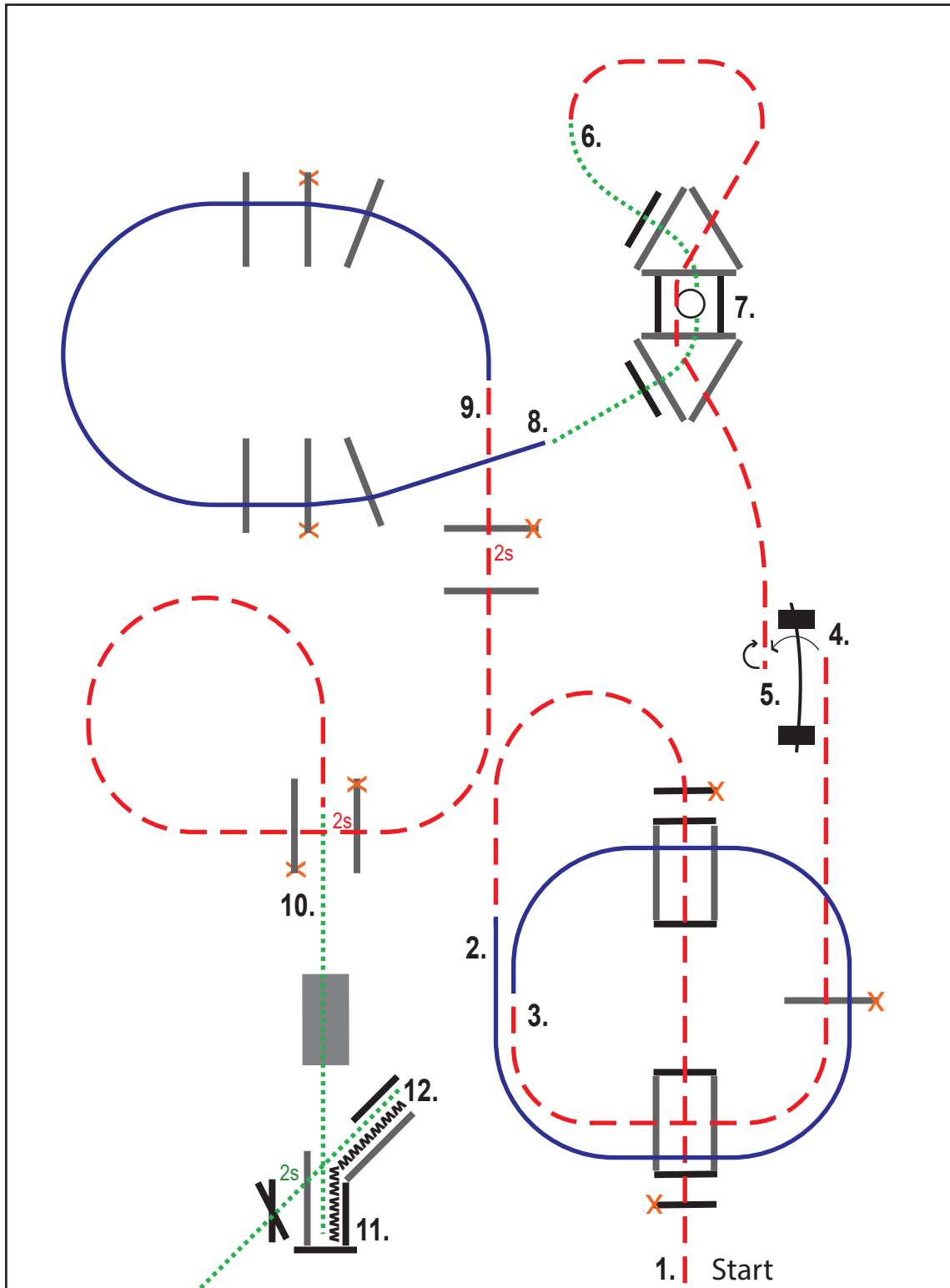

- 1. jog over poles
- 2. lope over poles left lead
- 3. jog over poles to gate
- 4. gate left hand
- 5. turn 180° right, jog over poles
- 6. walk over poles

- 7. turn 720° either way
- 8. lope over poles right lead
- 9. jog over poles
- 10. walk over bridge
- 11. back up
- 12. walk over pole and cross

- Schrittl
- - - - Trab
- Galopp
- MMM** Rückwärts
- \overline{nn} → Seitwärts
- Pylonen
- X Erhöhungen
- ⌋ Tor



designed by Nina Zwölfer

CWN-C ZNS/ARHA WTC Western Star Cup 1
 Wr. Neustadt/NÖ * 07.04. - 09.04.2023
 05 Trail Novice Amateur

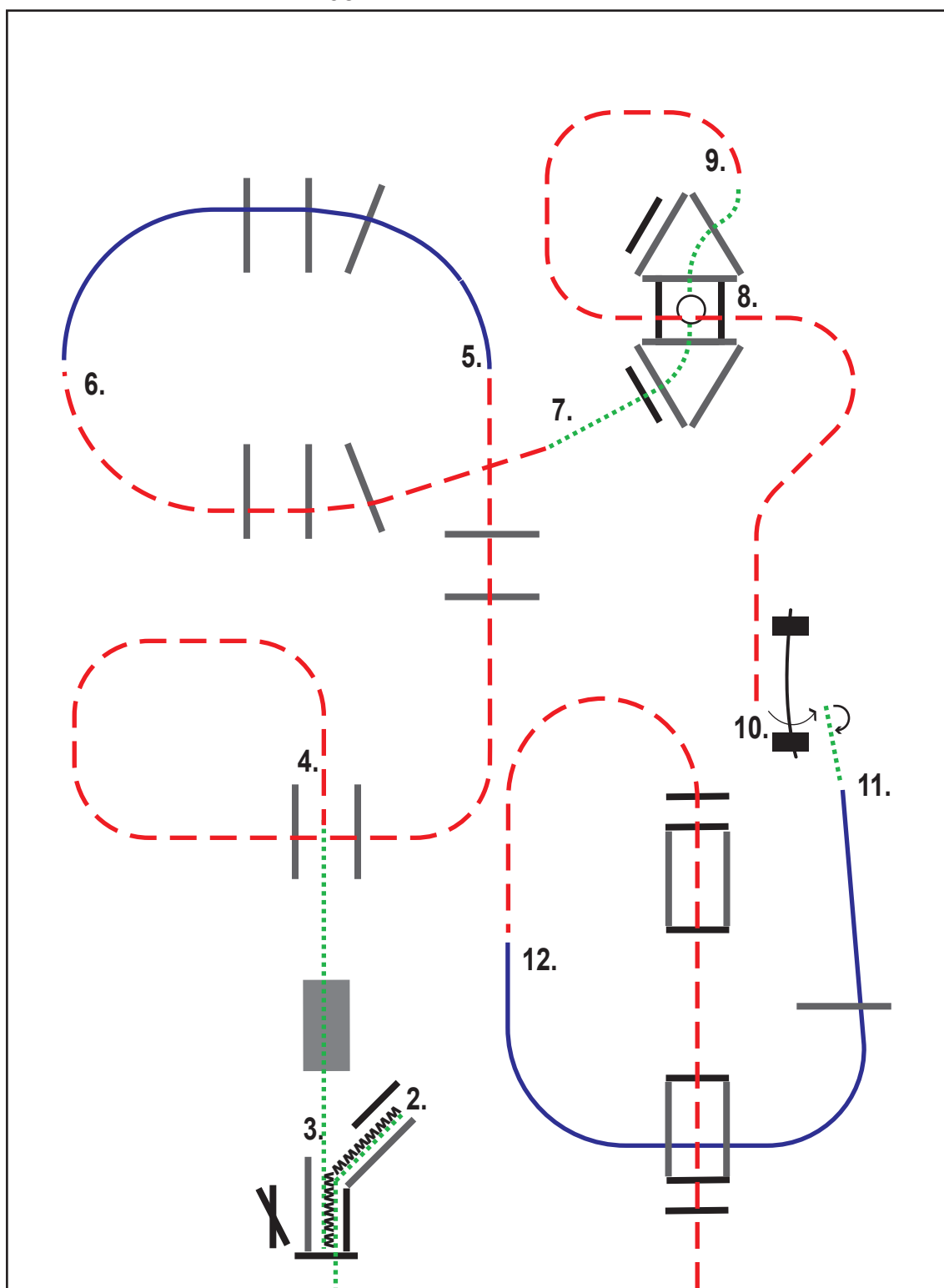

1. walk into chute
2. back up
3. walk over bridge
4. jog over poles
5. lope over poles left lead
6. jog over poles

7. walk over poles
8. turn 360° either way
9. jog over poles to gate
10. gate left hand, turn 180° right
11. lope over poles right lead
12. jog over poles

- | | |
|---------------|--------------|
| Schritt | ↔ Seitwärts |
| - - - - Trab | ○ Pylonen |
| ———— Galopp | X Erhöhungen |
| MMM Rückwärts | ⊥ Tor |



designed by Nina Zwölfer

CWN-C ZNS/ARHA WTC Western Star Cup 1
 Wr. Neustadt/NÖ * 07.04. - 09.04.2023
 27 Trail Open Prime Time

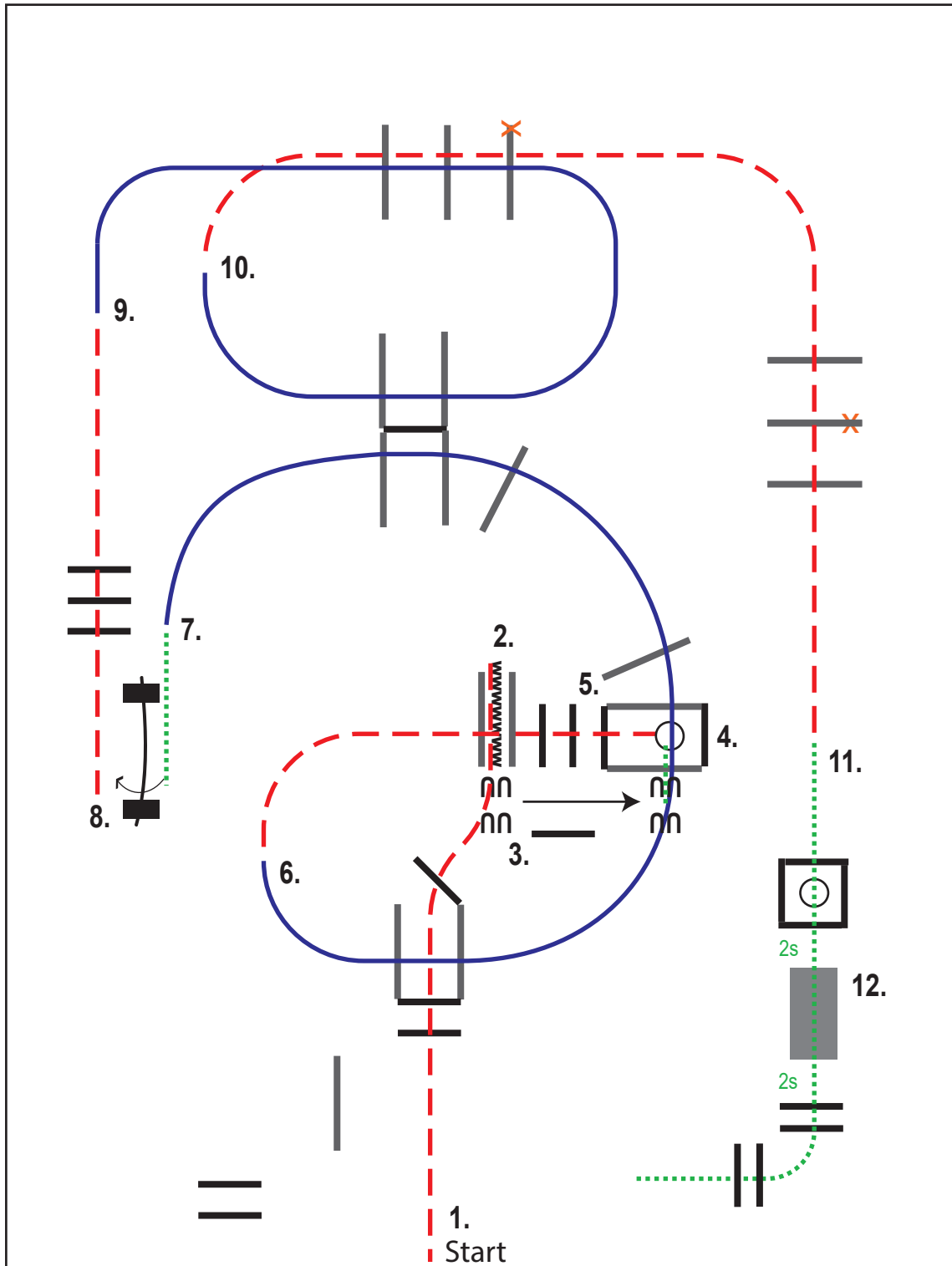

- 1. jog over poles into chute
- 2. back up
- 3. sidepass right
- 4. walk into box, turn 450° left
- 5. jog over poles
- 6. lope over poles left lead

- 7. walk to gate, gate right hand
- 8. jog over poles
- 9. lope over poles right lead
- 10. jog over poles
- 11. walk into box, turn 360° right
- 12. walk over bridge and poles

..... Schritt

- - - - - Trab

———— Galopp

MMM Rückwärts

Seitwärts

Pylonen

Erhöhungen

Tor



designed by Nina Zwölfer

CWN-C ZNS/ARHA WTC Western Star Cup 1
 Wr. Neustadt/NÖ * 07.04. - 09.04.2023
 28 Trail Rookie

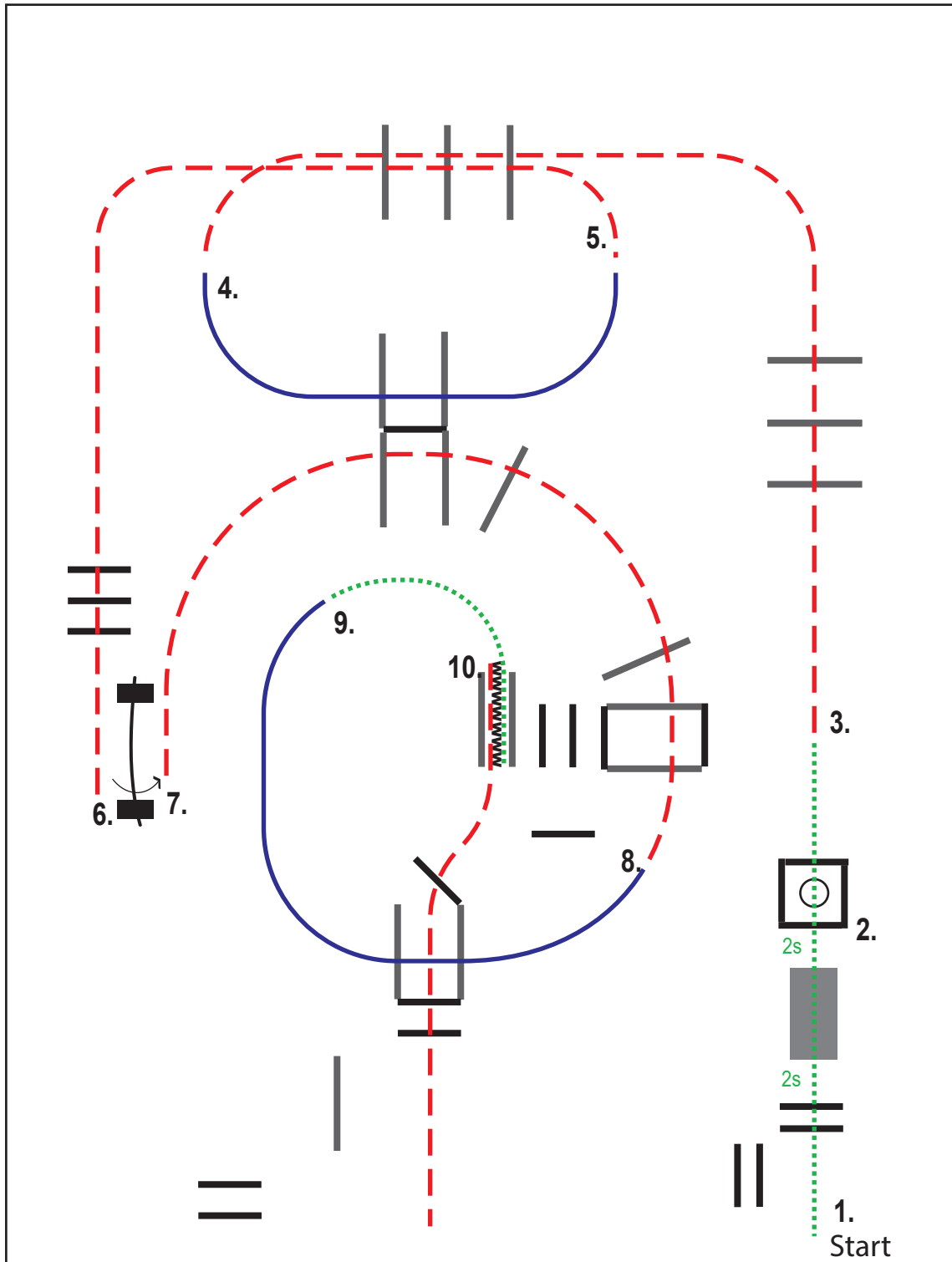

- | | |
|--|--------------------------------|
| 1. walk over poles and bridge | 7. jog over poles |
| 2. walk into box, turn 360° either way | 8. lope over poles right lead |
| 3. jog over poles | 9. walk into chute and back up |
| 4. lope over poles left lead | 10. jog over poles |
| 5. jog over poles | |
| 6. gate left hand | |

- | | |
|----------------|--------------|
| Schritt | ↔ Seitwärts |
| - - - - - Trab | ○ Pylonen |
| — Galopp | X Erhöhungen |
| MMM Rückwärts | ⌋ Tor |



designed by Nina Zwölfer

CWN-C ZNS/ARHA WTC Western Star Cup 1
 Wr. Neustadt/NÖ * 07.04. - 09.04.2023
 29 Trail Youth

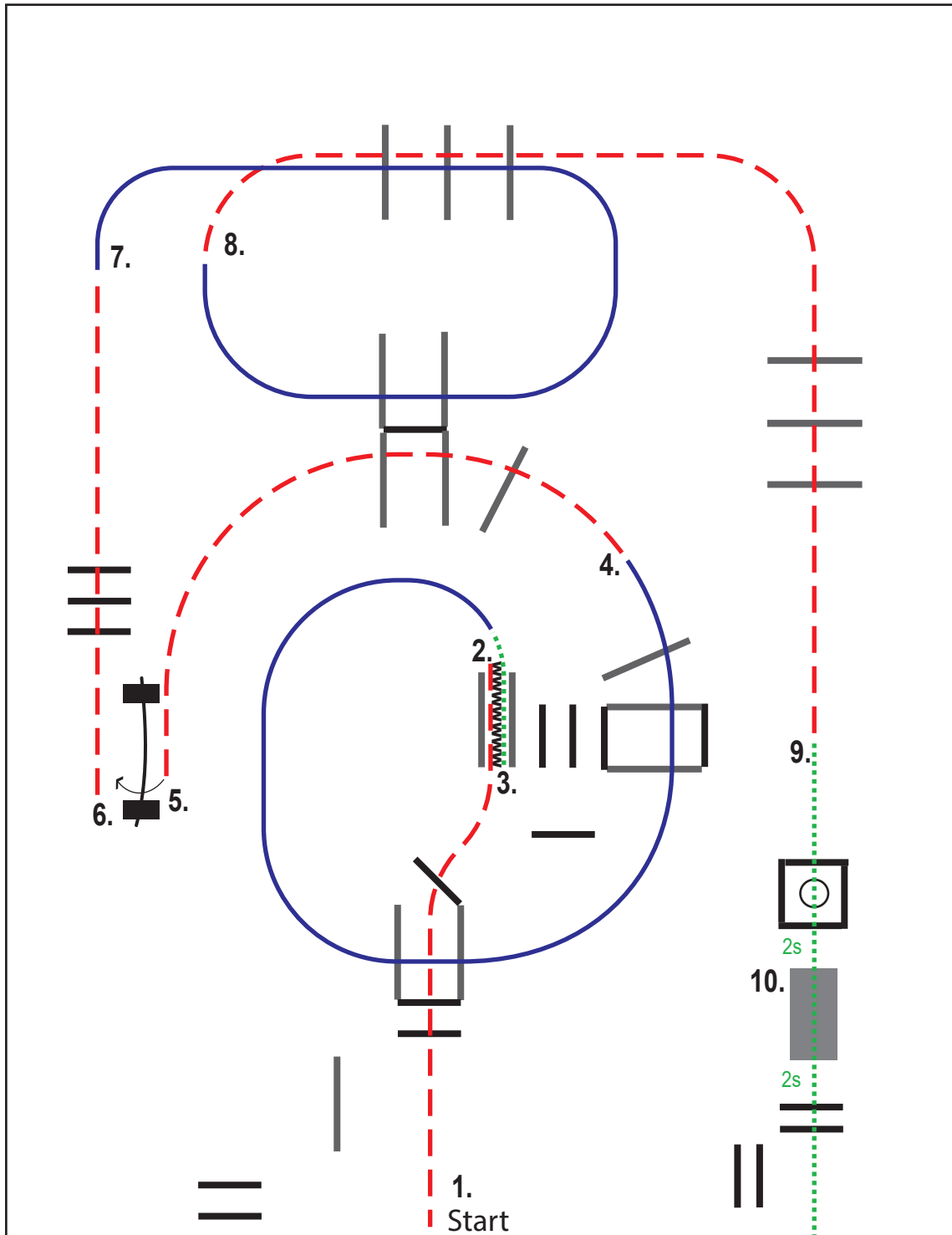

- 1. jog over poles into chute
- 2. back up and walk out
- 3. lope over poles left lead
- 4. jog over poles to gate
- 5. gate right hand
- 6. jog over poles

- 7. lope over poles right lead
- 8. jog over poles
- 9. walk into box, turn 360° either way
- 10. walk over bridge and poles

..... Schritt

- - - - - Trab

———— Galopp

MMM Rückwärts

↗ Seitwärts

○ Pylonen

X Erhöhungen

⊥ Tor



designed by Nina Zwölfer

CWN-C ZNS/ARHA WTC Western Star Cup 1
 Wr. Neustadt/NÖ * 07.04. - 09.04.2023
 30 Trail Novice Youth

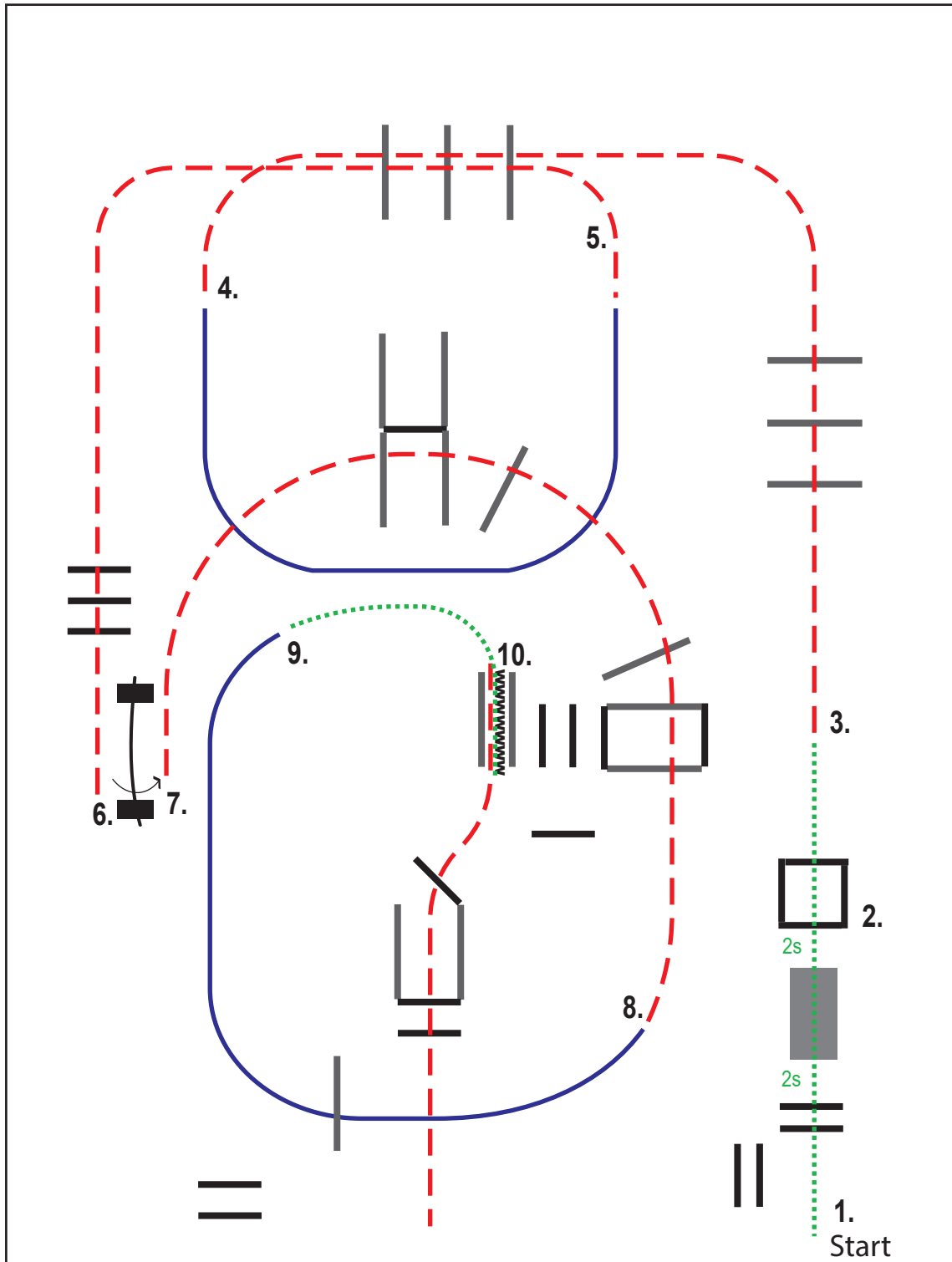

- | | |
|-------------------------------|--------------------------------|
| 1. walk over poles and bridge | 7. jog over poles |
| 2. walk through box | 8. lope over pole right lead |
| 3. jog over poles | 9. walk into chute and back up |
| 4. lope left lead | 10. jog out and over poles |
| 5. jog over poles | |
| 6. gate left hand | |

- | | |
|----------------|--------------|
| Schritt | ↔ Seitwärts |
| - - - - - Trab | ○ Pylonen |
| ———— Galopp | X Erhöhungen |
| MMM Rückwärts | ⊢ Tor |



designed by Nina Zwölfer

CWN-C ZNS/ARHA WTC Western Star Cup 1
 Wr. Neustadt/NÖ * 07.04. - 09.04.2023
 31 Trail Open

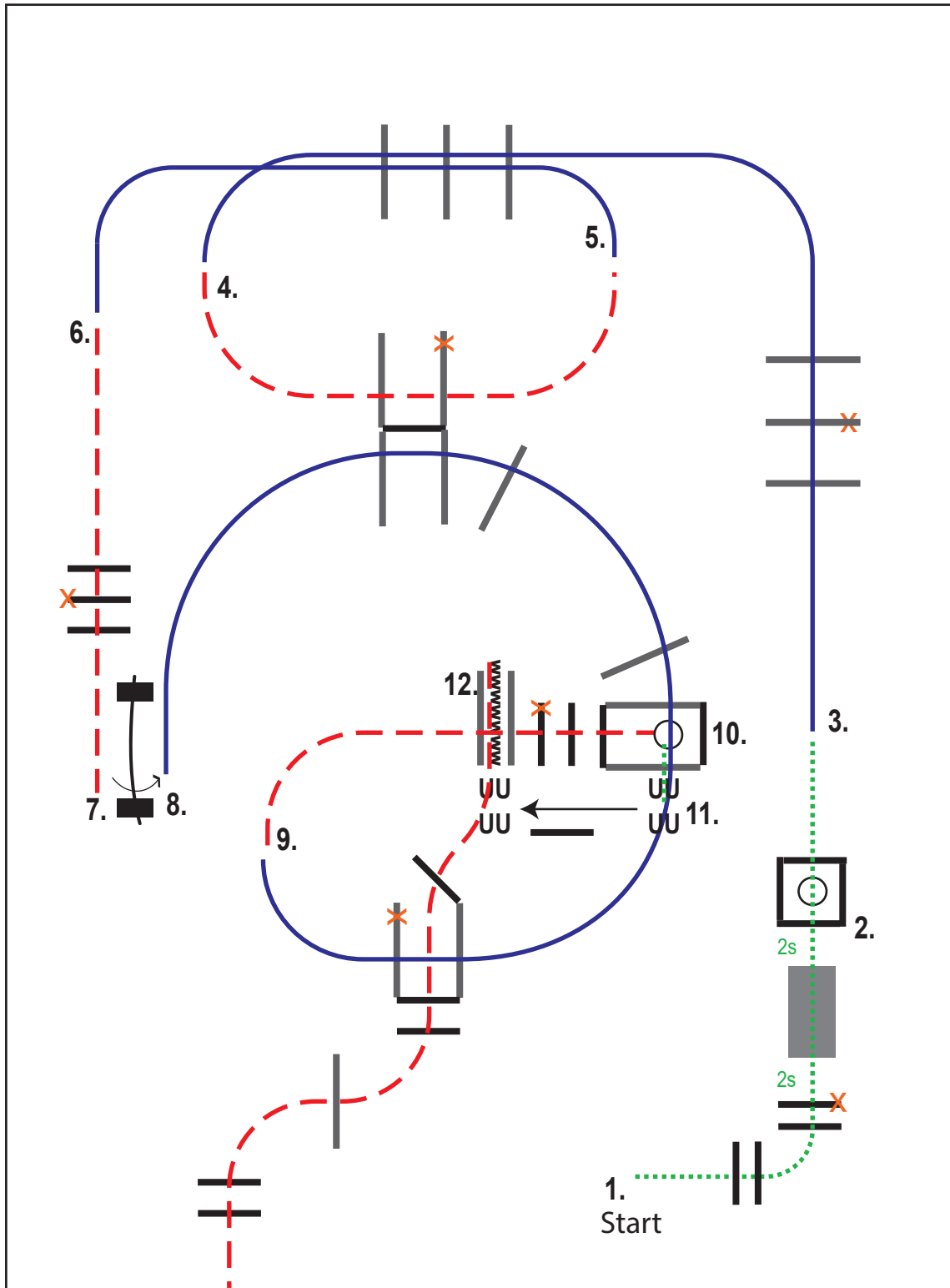

- | | |
|-----------------------------------|--------------------------------|
| 1. walk over poles and bridge | 7. gate left hand |
| 2. walk into box, turn 360° right | 8. lope over poles right lead |
| 3. lope over poles left lead | 9. jog over poles into box |
| 4. jog over poles | 10. turn 90° left, walk out |
| 5. lope over poles left lead | 11. sidepass right and back up |
| 6. jog over poles to gate | 12. jog over poles |

- | | |
|---------------|--------------|
| Schritt | ↔ Seitwärts |
| - - - - Trab | ○ Pylonen |
| — Galopp | X Erhöhungen |
| MMM Rückwärts | ⌋ Tor |



designed by Nina Zwölfer

CWN-C ZNS/ARHA WTC Western Star Cup 1
 Wr. Neustadt/NÖ * 07.04. - 09.04.2023
 32 Trail Kids Führzügel

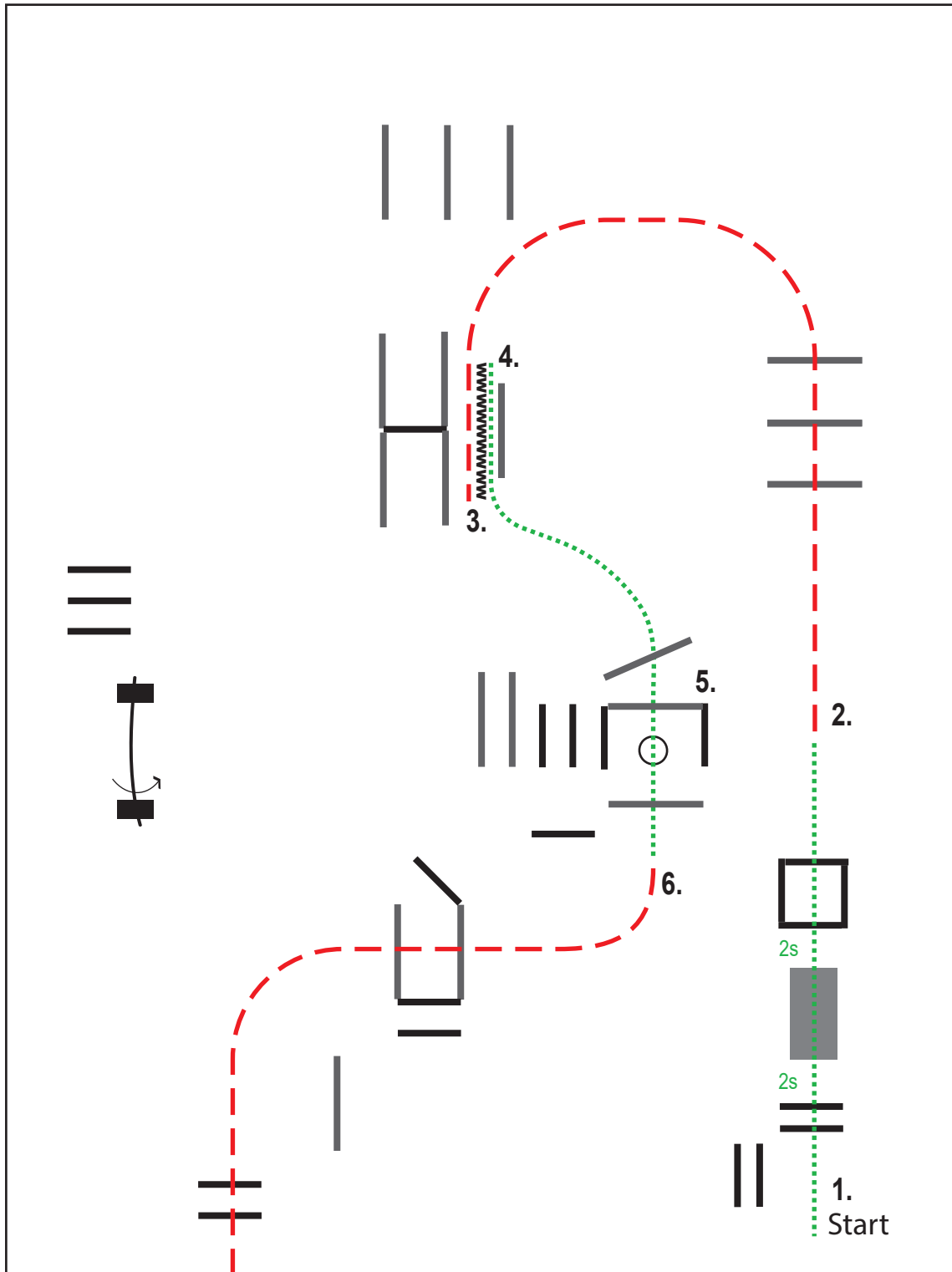

1. walk over poles, bridge and box
2. jog over poles into chute
3. backup
4. walk over pole into box
5. turn 360° right, walk out
6. jog over poles

- Schritt
- Trab
- Galopp
- MMM** Rückwärts

- Seitwärts
- Pylonen
- X** Erhöhungen
- Tor



designed by Nina Zwölfer

CWN-C ZNS/ARHA WTC Western Star Cup 1
 Wr. Neustadt/NÖ * 07.04. - 09.04.2023
 33 Trail Youngster

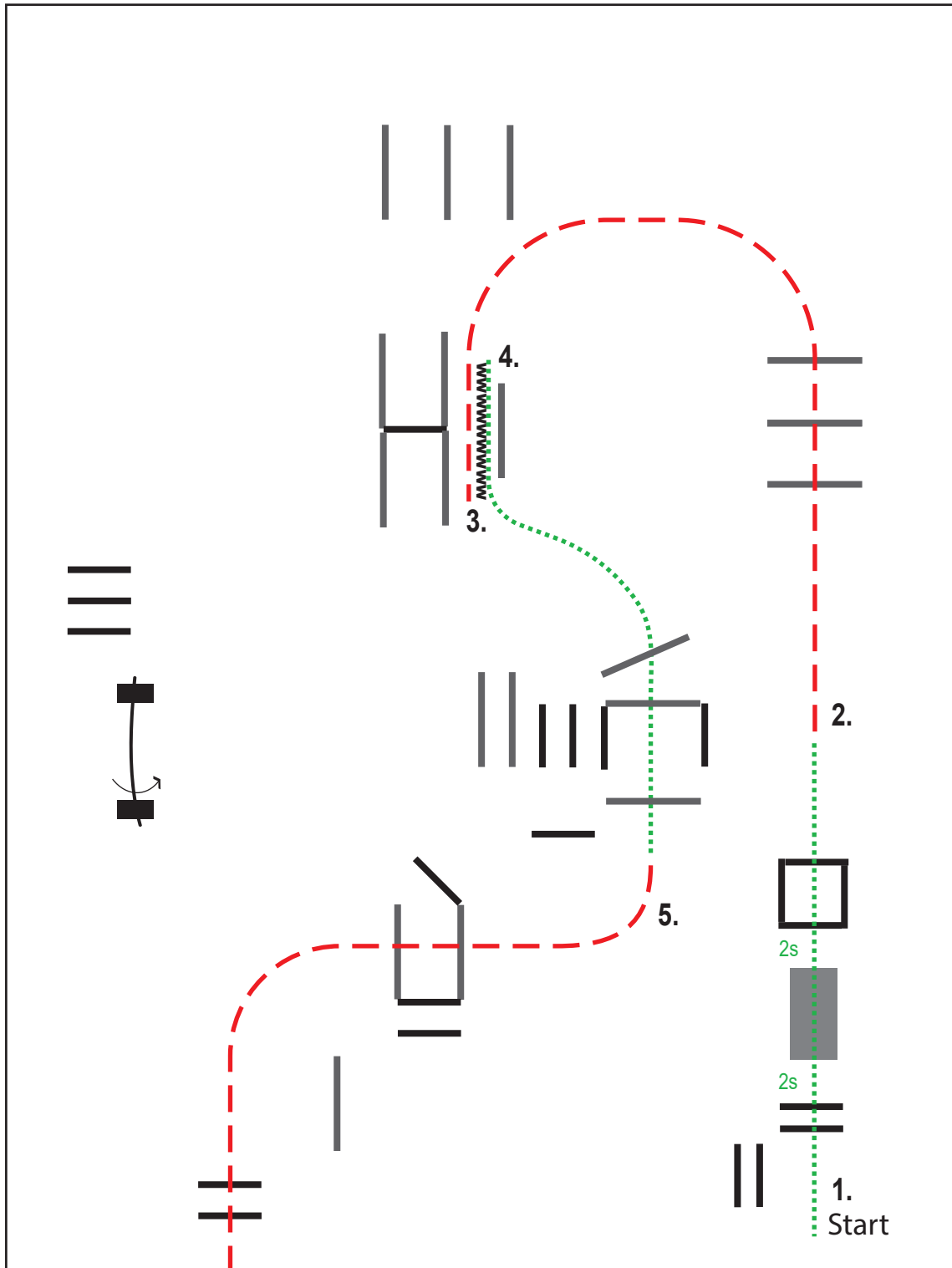

1. walk over poles, bridge and box
2. jog over poles into chute
3. backup
4. walk over poles
5. jog over poles

- Schrittlage
- Trab
- Galopp
- MMM** Rückwärts

- Seitwärts
- Pylonen
- Erhöhungen
- Tor



designed by Nina Zwölfer

CWN-C ZNS/ARHA WTC Western Star Cup 1
 Wr. Neustadt/NÖ * 07.04. - 09.04.2023
 63 Trail Youth

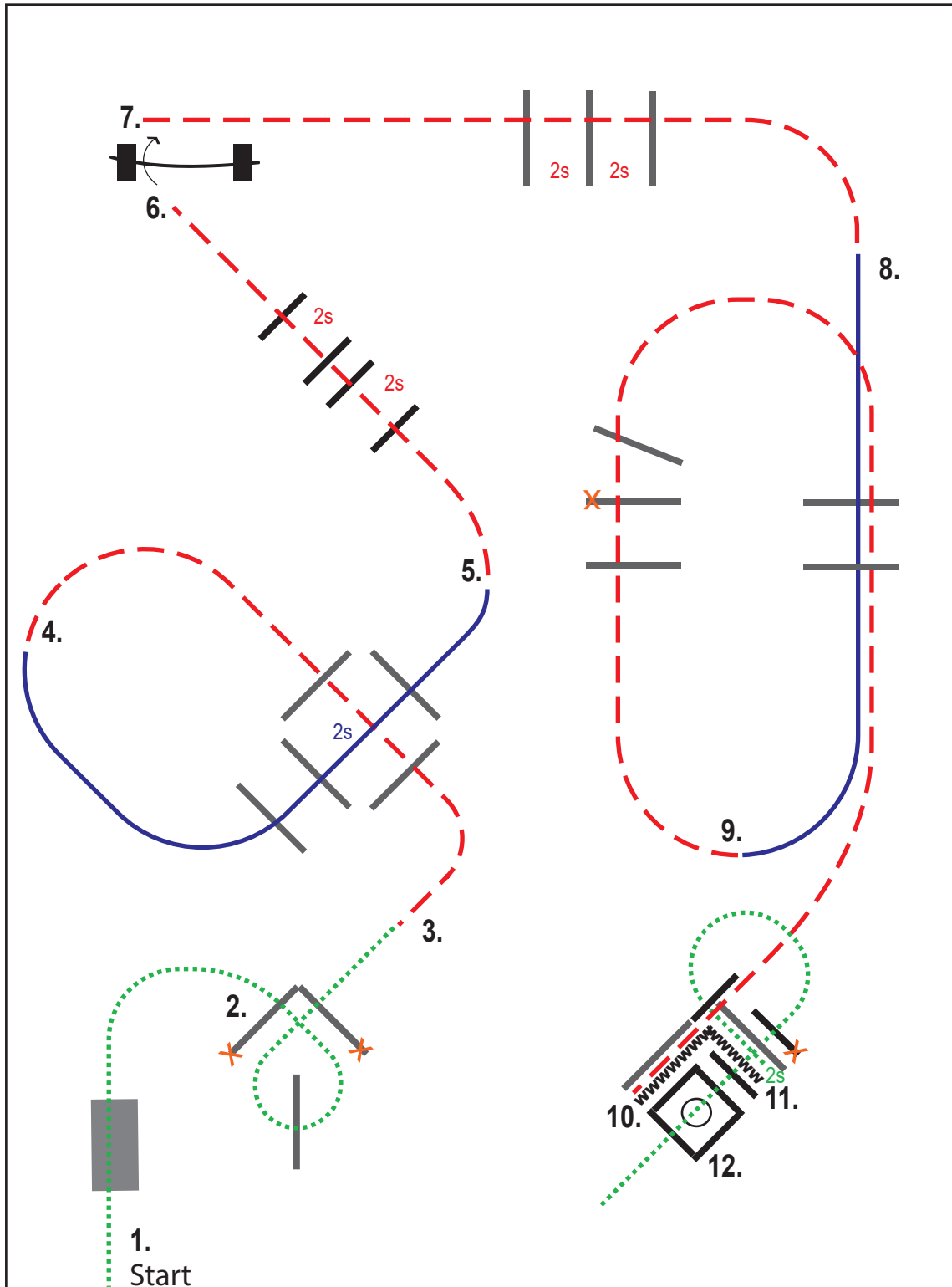

- 1. walk over bridge
- 2. walk over poles
- 3. jog over poles
- 4. lope over poles left lead
- 5. jog over poles to gate
- 6. gate right hand

- 7. jog over poles
- 8. lope over poles right lead
- 9. jog over poles into chute
- 10. back up „L“
- 11. walk over poles
- 12. walk into box, turn 360° either way

- Schrittl
- - - - Trab
- Galopp
- MMM Rückwärts
- ↔ Seitwärts
- Pylonen
- X Erhöhungen
- ⊢ Tor



designed by Nina Zwölfer

CWN-C ZNS/ARHA WTC Western Star Cup 1
 Wr. Neustadt/NÖ * 07.04. - 09.04.2023
 64 Trail Novice Amateur

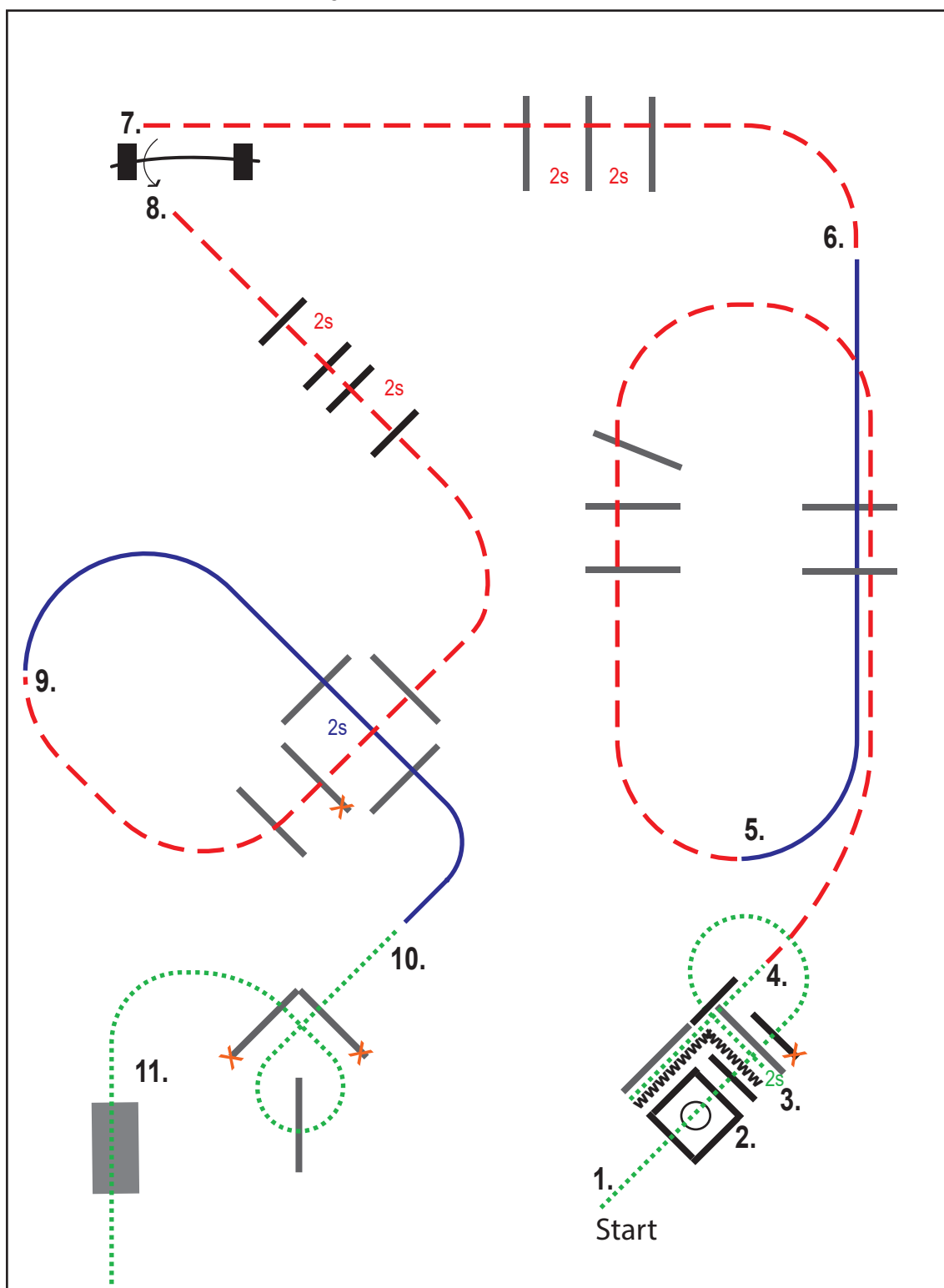

- 1. walk into box, turn 360° either way
- 2. walk out and over poles into chute
- 3. back up „L“ and walk out
- 4. jog over poles
- 5. lope over poles left lead
- 6. jog over poles to gate

- 7. gate left hand
- 8. jog over poles
- 9. lope over poles right lead
- 10. walk over poles
- 11. walk over bridge

- Schritt
- Trab
- Galopp
- MMM** Rückwärts
- $\frac{nn}{nn} \rightarrow$ Seitwärts
- O** Pylonen
- X** Erhöhungen
- T** Tor



designed by Nina Zwölfer

CWN-C ZNS/ARHA WTC Western Star Cup 1
 Wr. Neustadt/NÖ * 07.04. - 09.04.2023
 65 Trail Amateur

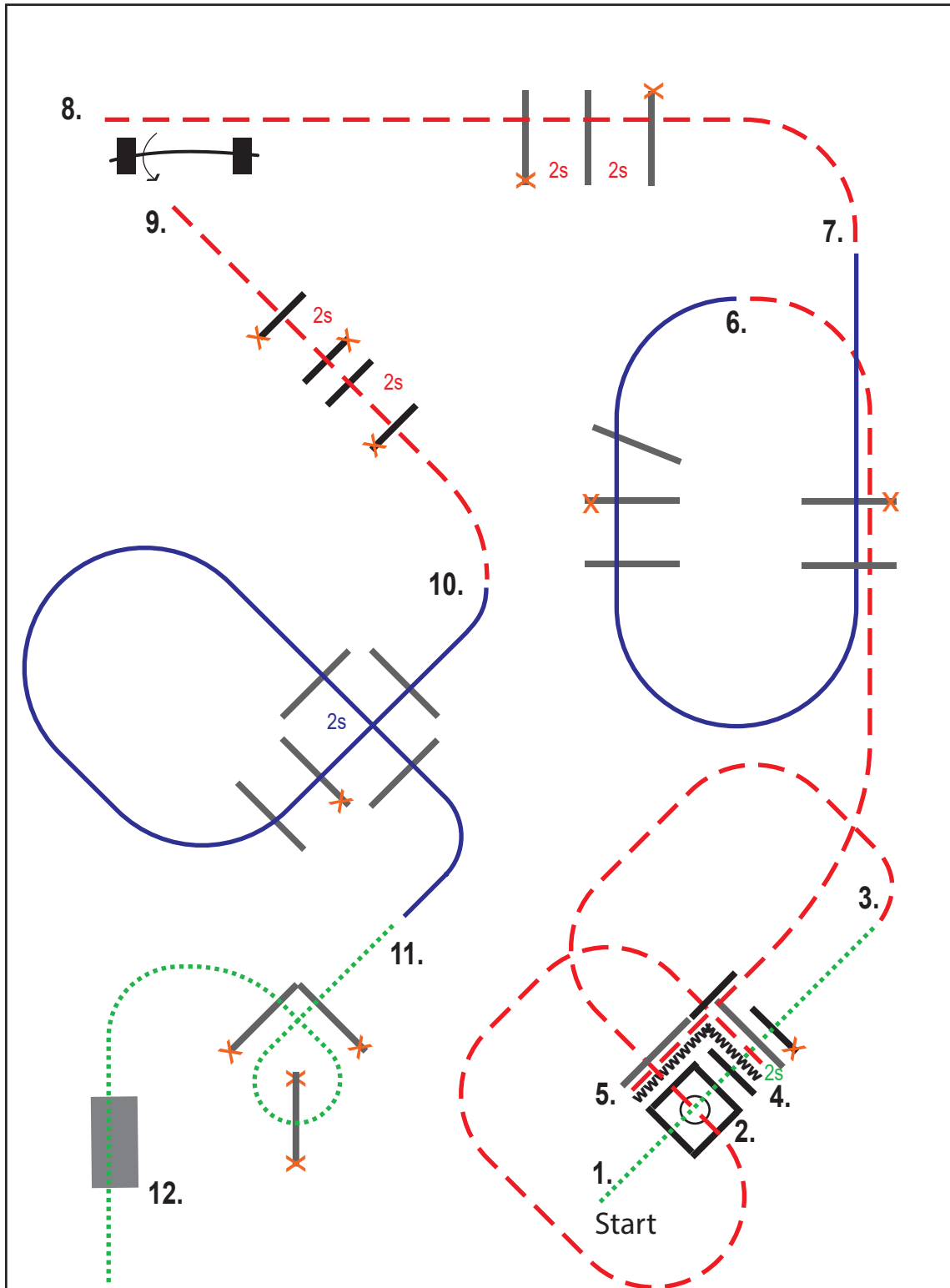

- 1. walk into box, turn 720° either way
- 2. walk out and over poles
- 3. jog over poles into chute
- 4. back up „L“
- 5. jog over poles
- 6. lope over poles left lead

- 7. jog over poles to gate
- 8. gate left hand
- 9. jog over poles
- 10. lope over poles right lead
- 11. walk over poles
- 12. walk over bridge

- Schrittl
- - - - Trab
- Galopp
- MMM** Rückwärts
- \overline{nn} → Seitwärts
- Pylonen
- X Erhöhungen
- H Tor



designed by Nina Zwölfer