

# STYRIAN PAINT HORSE CLASSIC 2024

## #1+ VSH1 Showmanship Novice Youth

Show Dates: 07-25-07-28 2024

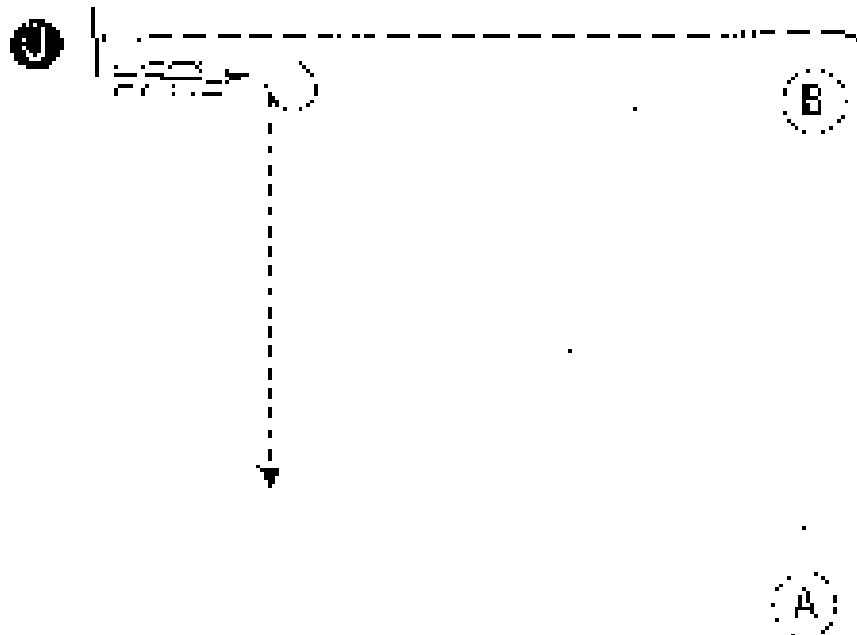

Be ready at A

1. Walk to B.
2. Trot around B and to judge.
3. Stop and set up for inspection.
4. When dismissed, ask for horse length.
5. Turn 90 degrees and walk straight off.

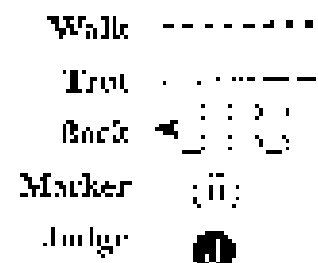

[501-23]

Pattern Provided by:  
*Johanna Vorraber*

# STYRIAN PAINT HORSE CLASSIC 2024

\*2 J\* Showmanship YHS1 XSH1 Youth (18)

Show Date: 07/25-07/26/2024

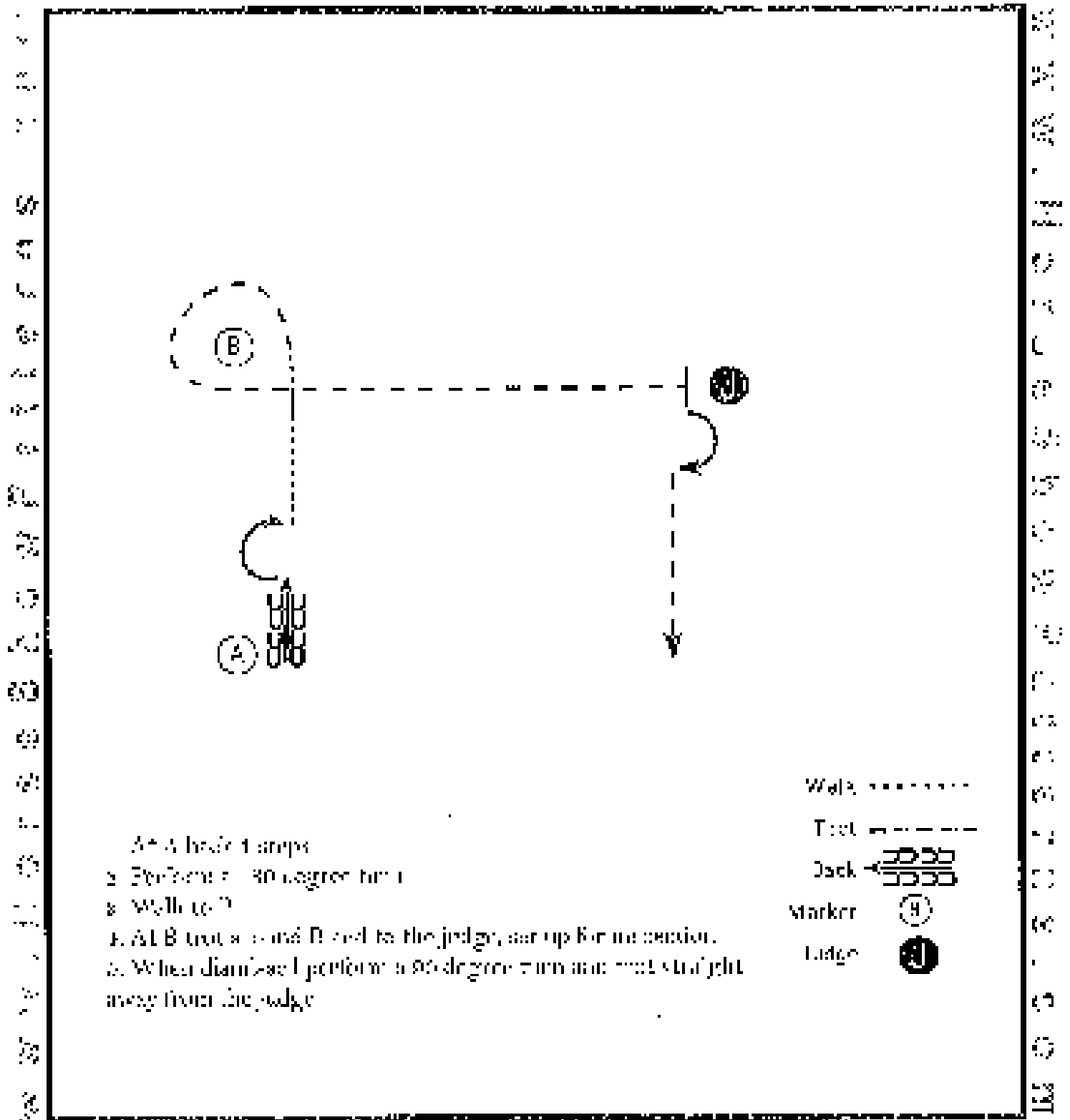

[S2-1]

Pattern Provided by:  
*Johanna Vorraber*

© 2024 American Paint Horse Association. All rights reserved.

# STYRIAN PAINT HORSE CLASSIC 2024

## \*4\* NSH1 Showmanship NA

Show Date: 07-25-07-30 2024

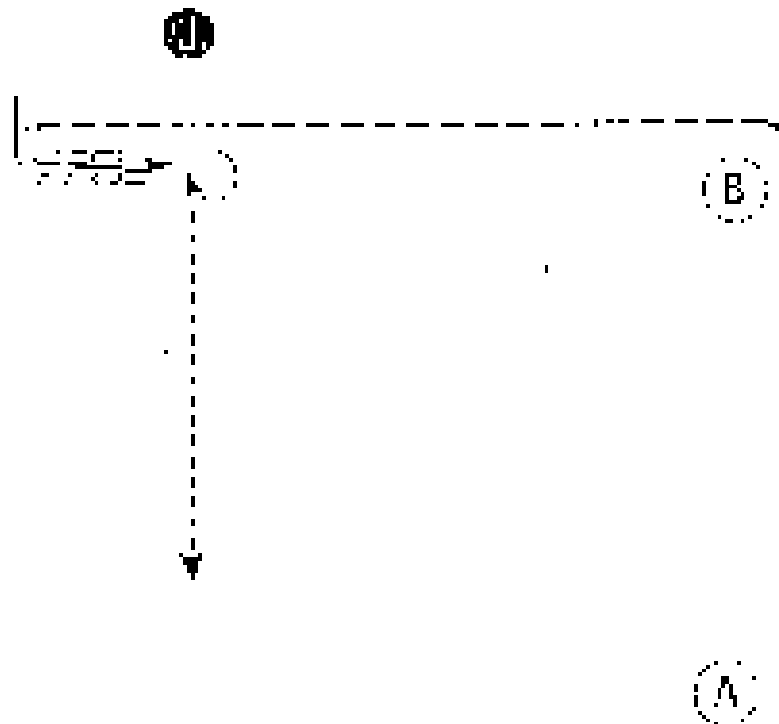

Be ready at A.

1. Walk to B.
2. Trot around B and past judge.
3. Stop past judge and look until hind end of horse is even with judge.
4. Turn 90 degrees and set up for inspection.
5. When dismissed, walk straight away from judge.

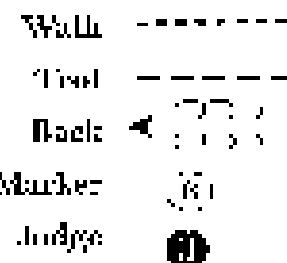

[S/2-23]

Pattern Provided by:

*Johanna Vorraber*

© 2024 American Paint Horse Association. All rights reserved.

# STYRIAN PAINT HORSE CLASSIC 2024

## \*5+6\* Showmanship ASHA/ABSH A

Show Dates: 07-25-07-26 2024

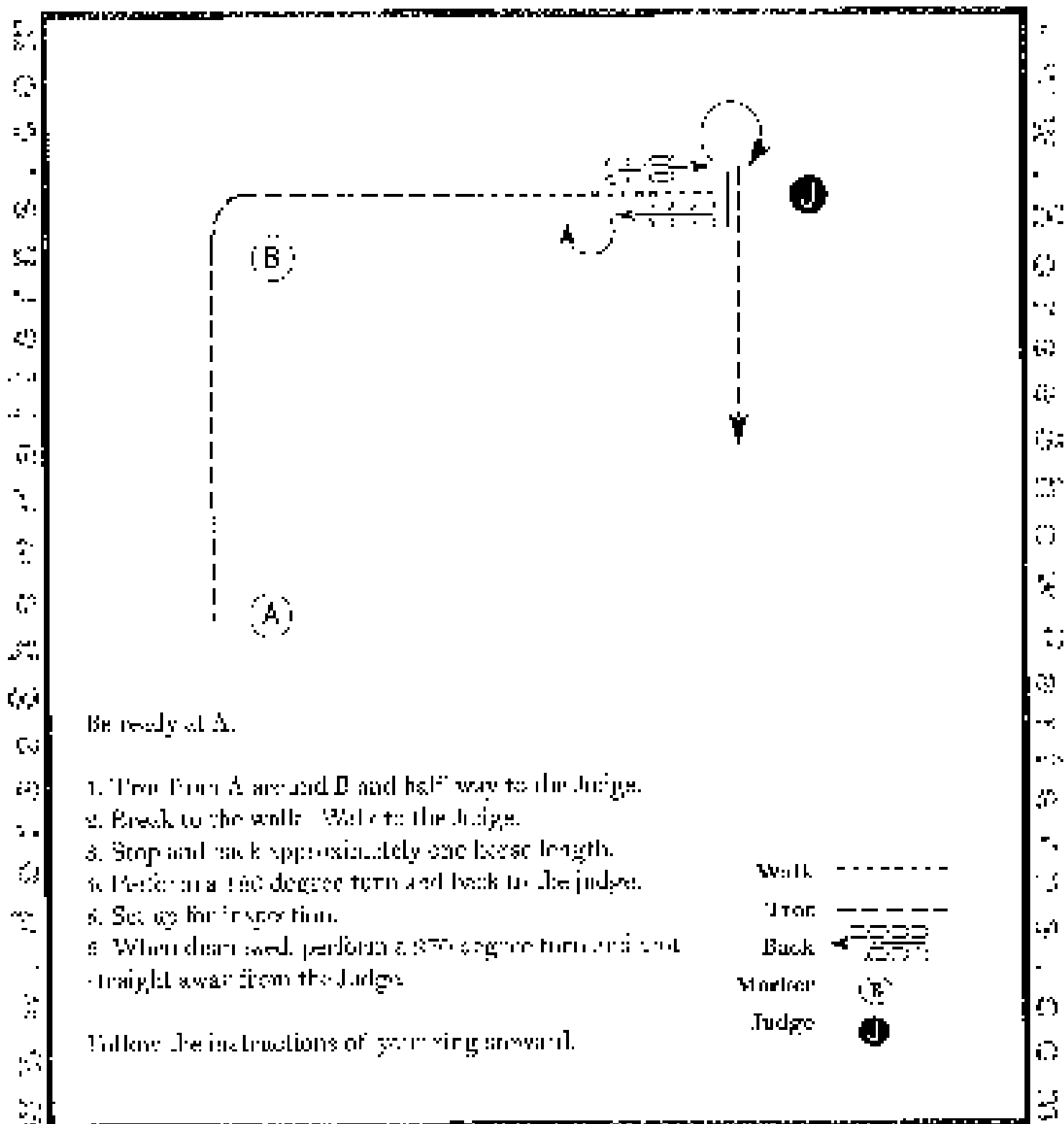

[9/3-33]

Pattern Provided by:

*Johanna Vorraber*

www.styrianpainthorse.com ASHA/ABSH A

# STYRIAN PAINT HORSE CLASSIC 2024

\*69+75\* HSE VEE1+75 HSE (Nov. Yout & Nov. Amateur)

Show Date: 07.21-07-28.2024

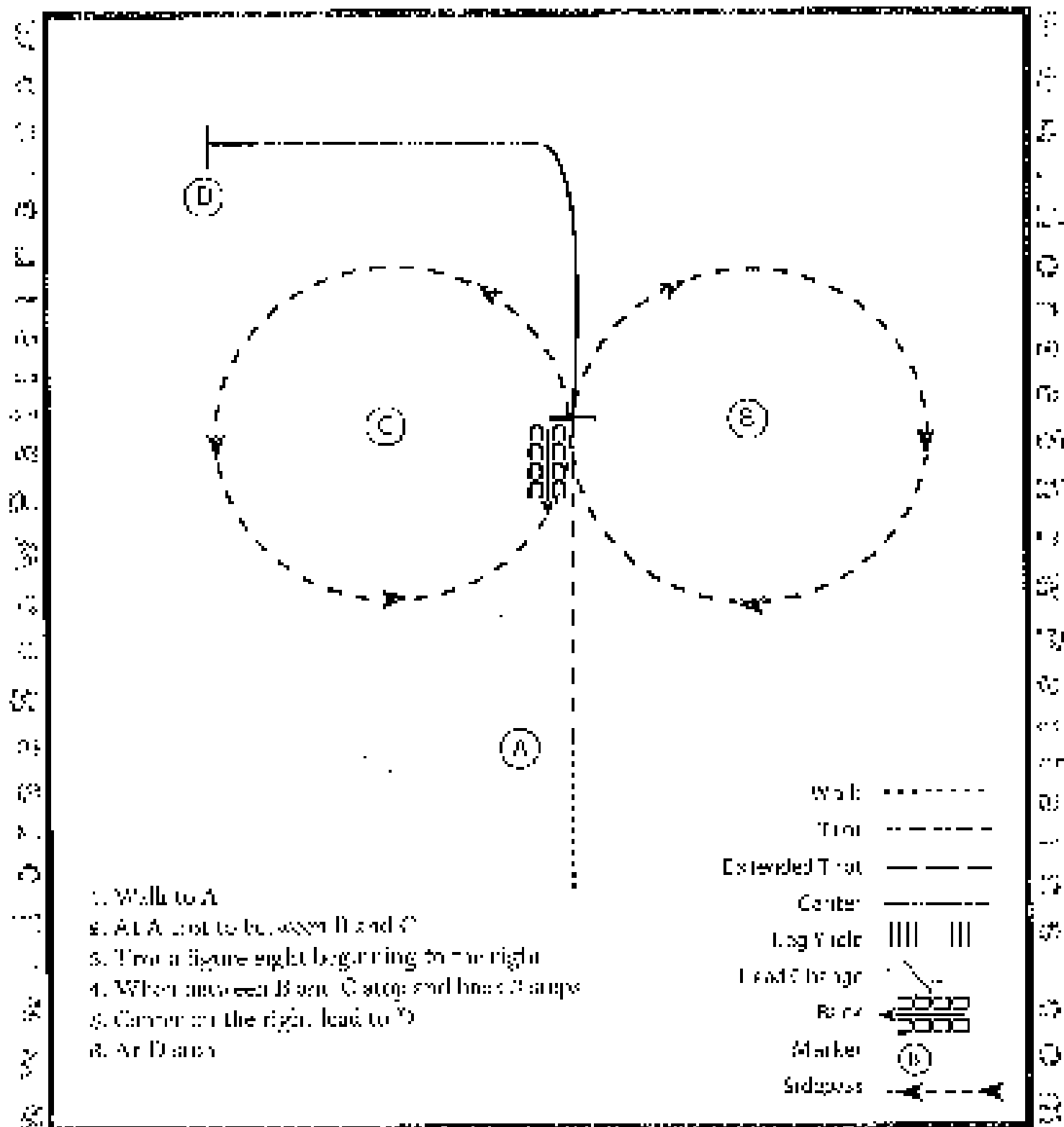

[HSE/1-4]

Pattern Provided by:  
*Johanna Vorraber*

# STYRIAN PAINT HORSE CLASSIC 2024

\*70 90, 71 90\* HSE SPD und reg. (Youth and Amateur)

Show Dates: 07-25-07-28 2024

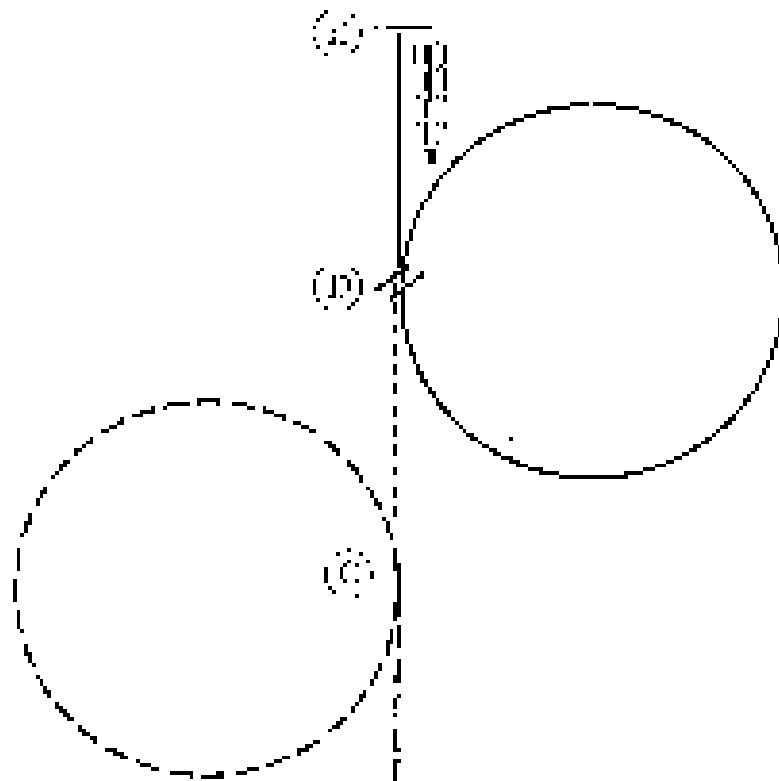

Be ready at A

1. Start at A to B.
2. Posture test on the left diagonal to C.
3. Change diagonals and circle on the left at C.
4. Walk from C to D.
5. Center a circle to the right at D.
6. Change leads at D and center to E.
7. Stop at E and back approximately one horse length.

Exit at A test

Follow the instructions of your ring steward

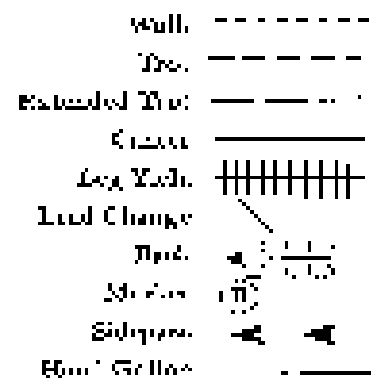

[HSE12-38]

Pattern Provided by:

*Johanna Vorraber*

© 2014 American Paint Horse Association

# STYRIAN PAINT HORSE CLASSIC 2024

Show Date: 07-25-07-28 2024

## 76 Open allbreed

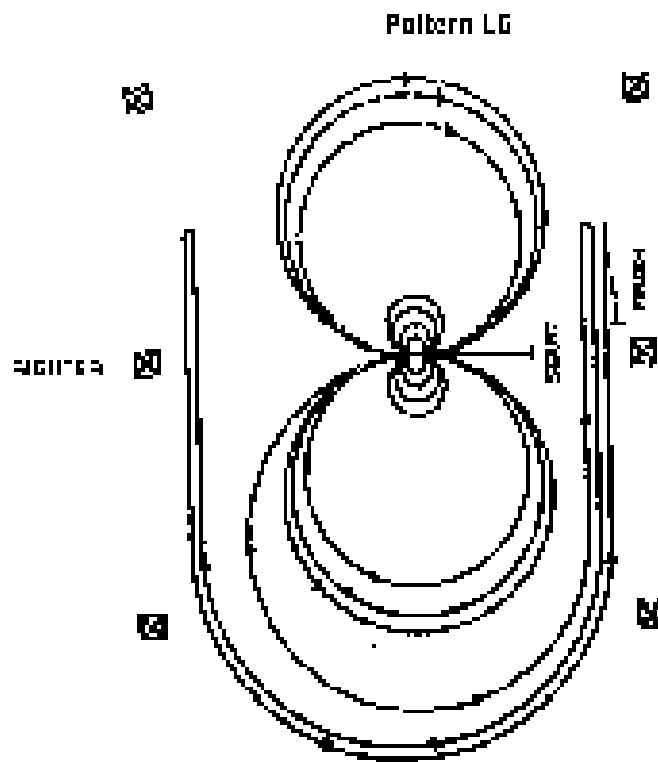

1. Im Schritt im Vorwärts mit Rhythmus in die Runde 4 Spinnenteile.
2. 4 Spinnenteile Vorwärts.
3. Schritt im Schritttempo, 8 Taktteil eines 4-eckigen zwei Taktteiligen? und das mit dem in den Taktteil klein und lang sein. Taktteil des neuen Taktteil Teil des Schritttempo.
4. 8 Taktteil des neuen zwei Taktteiligen und schnell: ein Taktteil 2 Taktteil lang sein 1 Taktteil des neuen zwei Taktteiligen.
5. Unklar, schneller Taktteil nach links, in Schritttempo, zweite 1/2 Taktteil in der linken Seite über 1/2 Taktteil lang sein, in Schritttempo, 2 Taktteil von links in der linken Seite, dann 1/2 Taktteil nach rechts sein in Schritttempo.
6. Die Taktteil umrunden in der rechten Seite nach dem Mittelmaß von in Schritttempo 1/2 Taktteil in der linken Seite einleitend Schritttempo, dann 1/2 Taktteil nach links, in Schritttempo.
7. Die Taktteil umrunden in der rechten Seite nach dem Mittelmaß von in Schritttempo 1/2 Taktteil in der linken Seite einleitend Schritttempo, dann 1/2 Taktteil nach links, in Schritttempo, dann 1/2 Taktteil nach rechts, in Schritttempo.

Zur Feder und zum Ausgang zurück sein.

# STYRIAN PAINT HORSE CLASSIC 2024

#80, ZNS Amateur (all breed)

Show Date: 07-26-07-28 2024

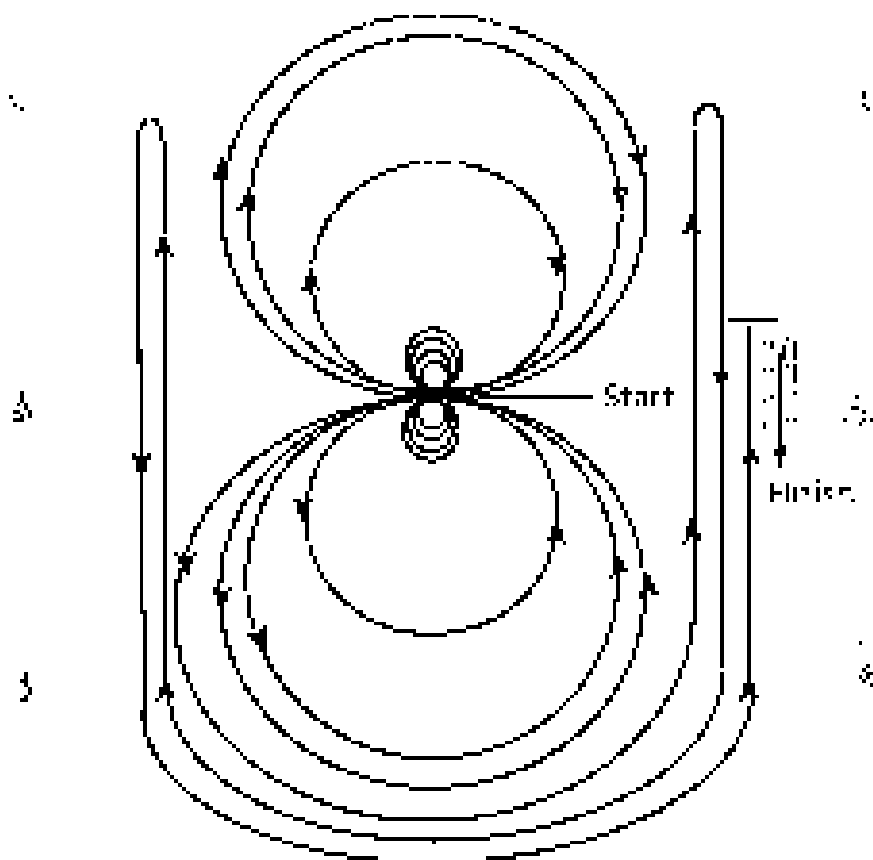

Horses may work either to the center of the arena, beginning at the center of the arena, along the left wall or across.

1. Get into line up to the right.
  2. Complete four spins out on the left side.
  3. Begin long and slow lead, complete three circles to the left the first two circles large and fast; the third circle small and slow. Change sides at the center of the arena.
  4. Complete three circles to the right the first two circles large and fast, the third circle small and slow. Change leads at the center of the arena.
  5. Begin a long and slow lead to the left but do not cross the line. Run on the right side of the arena past the center marker and do a right wall lead at least twenty feet (6.09m) from the wall or fence - no hesitation.
  6. Complete two small previous circle but do not cross this circle. Run on the left side of the arena past the center marker and do a left wall lead at least twenty feet (6.09m) from the wall or fence - no hesitation.
  7. Complete two small previous circle but do not cross this circle. Run up the right side of the arena past the center marker and do a shift of lead at least twenty feet (6.09m) from the wall or fence. Back up at least ten feet (3m). Finish to demonstrate the execution of the pattern.
- Rider may dismount and drop leads to the designated judge.

[R/NR/HAP-6]

Pattern Provided by:

*Johanna Vorraber*

2024 by the American Paint Horse Association





# STYRIAN PAINT HORSE CLASSIC 2024

Show Date: 07-25-07-28 2024 11:34-85+86 Open all breeds + APHA reg. + SHB

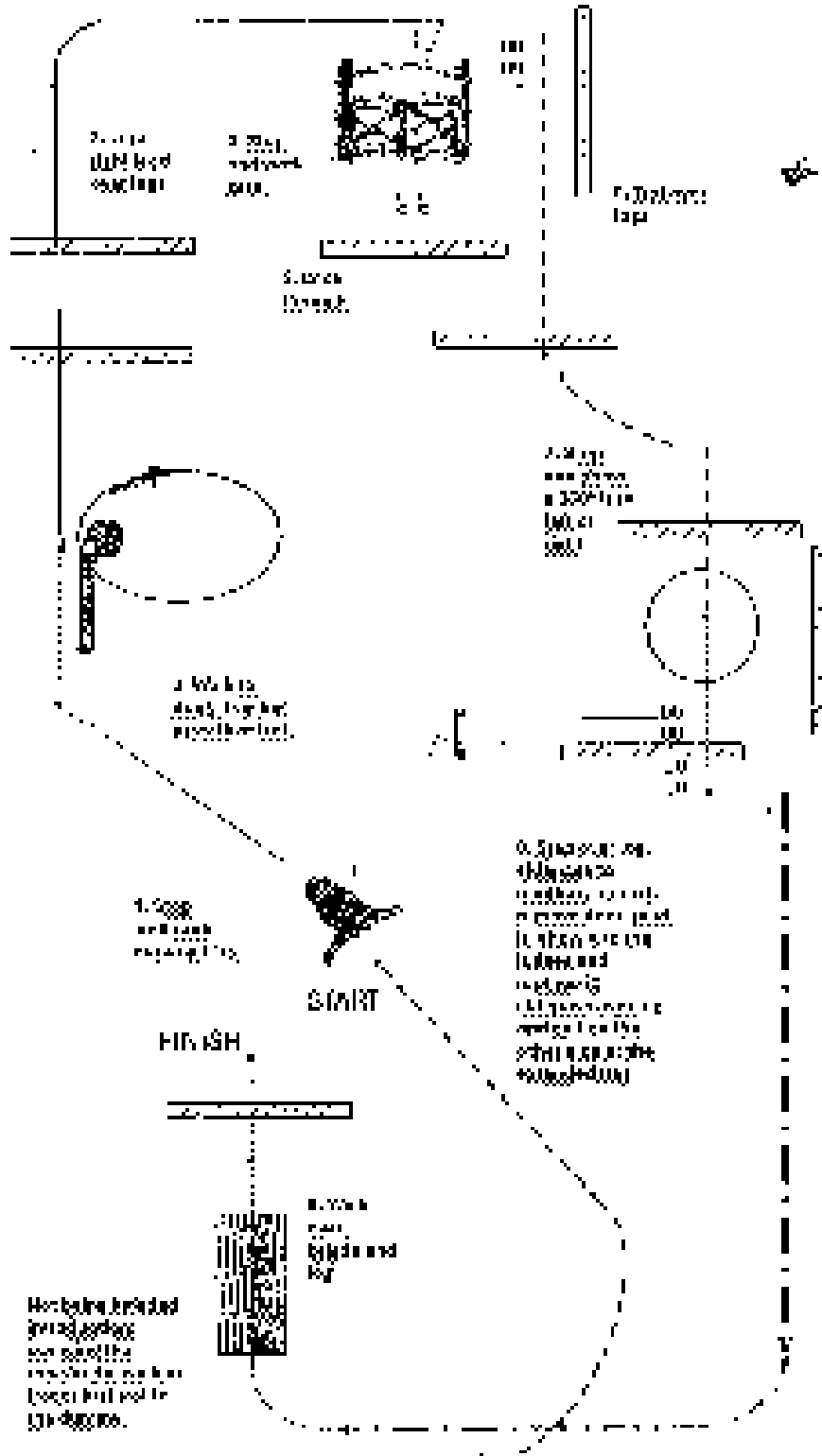

Work with jump (width 1.50m)

3. Table

START

FINISH

Work with jump (width 1.50m)

3. Table

# STYRIAN PAINT HORSE CLASSIC 2024

\*105 106 107 109\* WHMS (all breed APHA)

Show Date: 07-25-07-28 2024

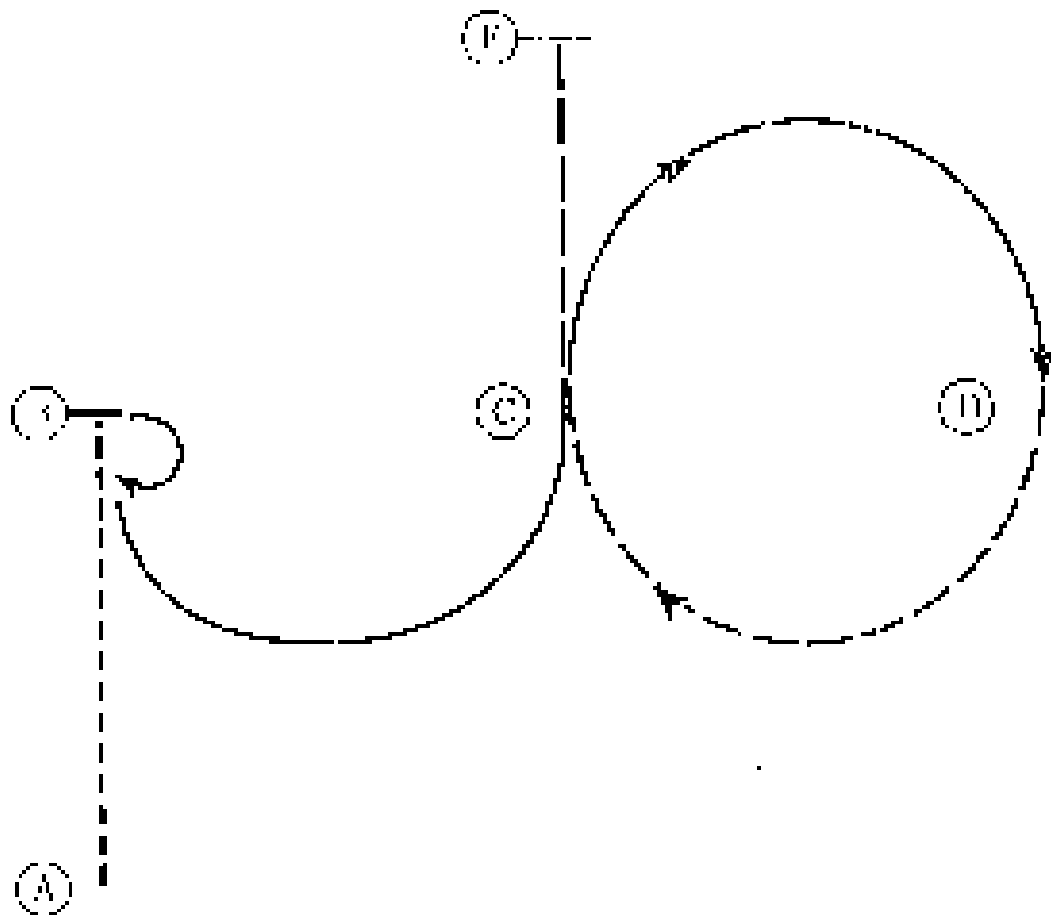

1. Jog A to B.
2. At B stop and perform a 180 degree turn to the right.
3. Execute the right lead in a half circle to C.
4. At C maintain the right lead in a half circle to D.
5. At D execute the jog in a half circle to E and continue to F.
6. At F stop.

Walk	-----
Trot	- - - - -
Extended Trot	— — — — —
Canter	— — — — —
Leg Yield	
Lead Change	↙ ↘
Back	← ← ← ← ← → → → → →
Marker	(u)
Sidepass	← — — — — →

[WH2-4]

Pattern Provided by:  
*Johanna Vortaber*

©2024 Vortaber Styria, Austria. All Rights Reserved

# STYRIAN PAINT HORSE CLASSIC 2024

\*108+110+111\* WHMS (SPB + regular + all breed)

Show Dates: 07-25-07-26-2024

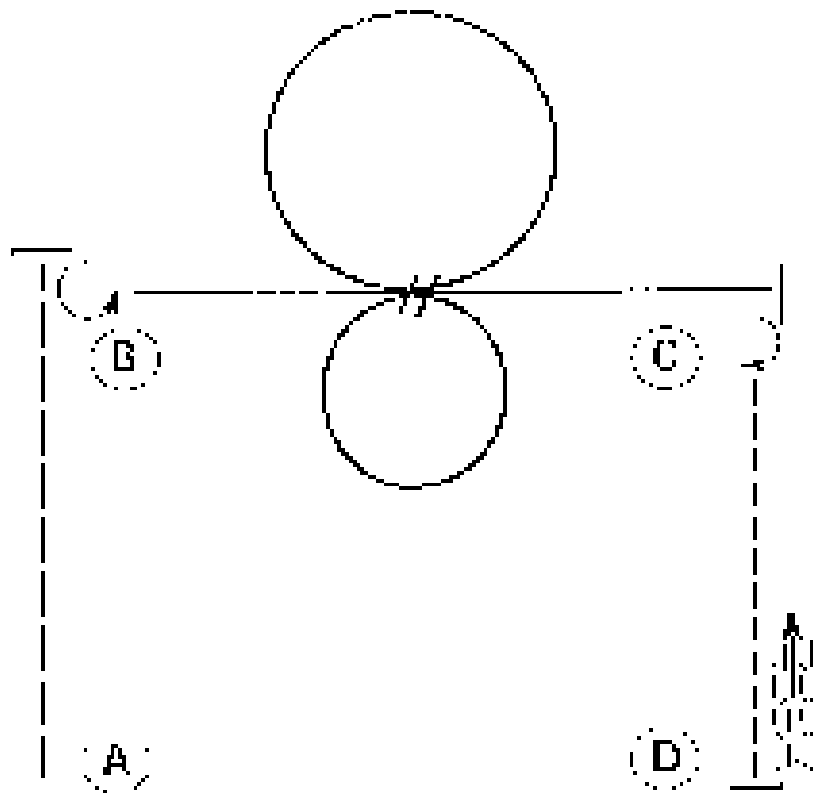

Be ready at A.

1. Extended trot from A past B.
2. Stop just B and perform a 270 degree turn to the left.
3. Lope on the right lead halfway to C.
4. Perform a small, slow circle to the right.
5. Change leads and perform a large, fast circle to the left.
6. Continue to lope past C and stop.
7. Perform a 180 turn to the right.
8. Jog to D.
9. Stop and back approximately one horse length.

Walk	-----
Jog	-----
Extended Jog	-----
Lope	-----
Lead Change	
Back	
Marker	(B)

Follow the instructions of your ring steward.

[WH/2-08]

Pattern Provided by:

*Johanna Vorraber*

© 2014 American Quarter Horse Association, All Rights Reserved

# STYRIAN PAINT HORSE CLASSIC 2024

\*117+118<sup>s</sup> ReRiding (Amateur SPB und regular)

Show Date: 07-25-07-28 2024

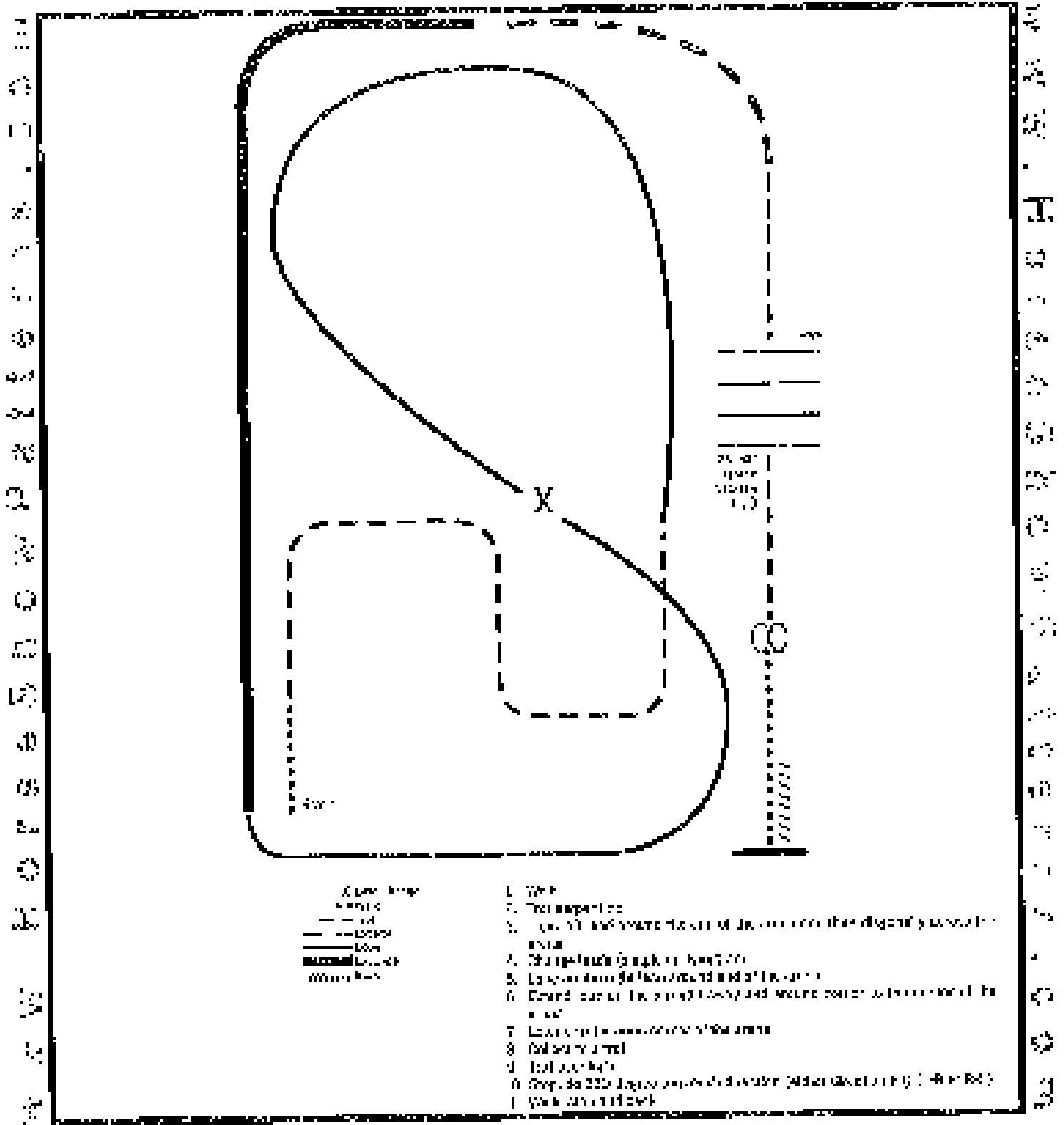

[RR/ADHA-3]

Pattern Provided by:  
*Johanna Vorraber*

# SYRIAN PAINT HORSE CLASSIC 2024

#119+120 ReRiding (\$PB + regular)

Show Date: 07-26-07-28 2024

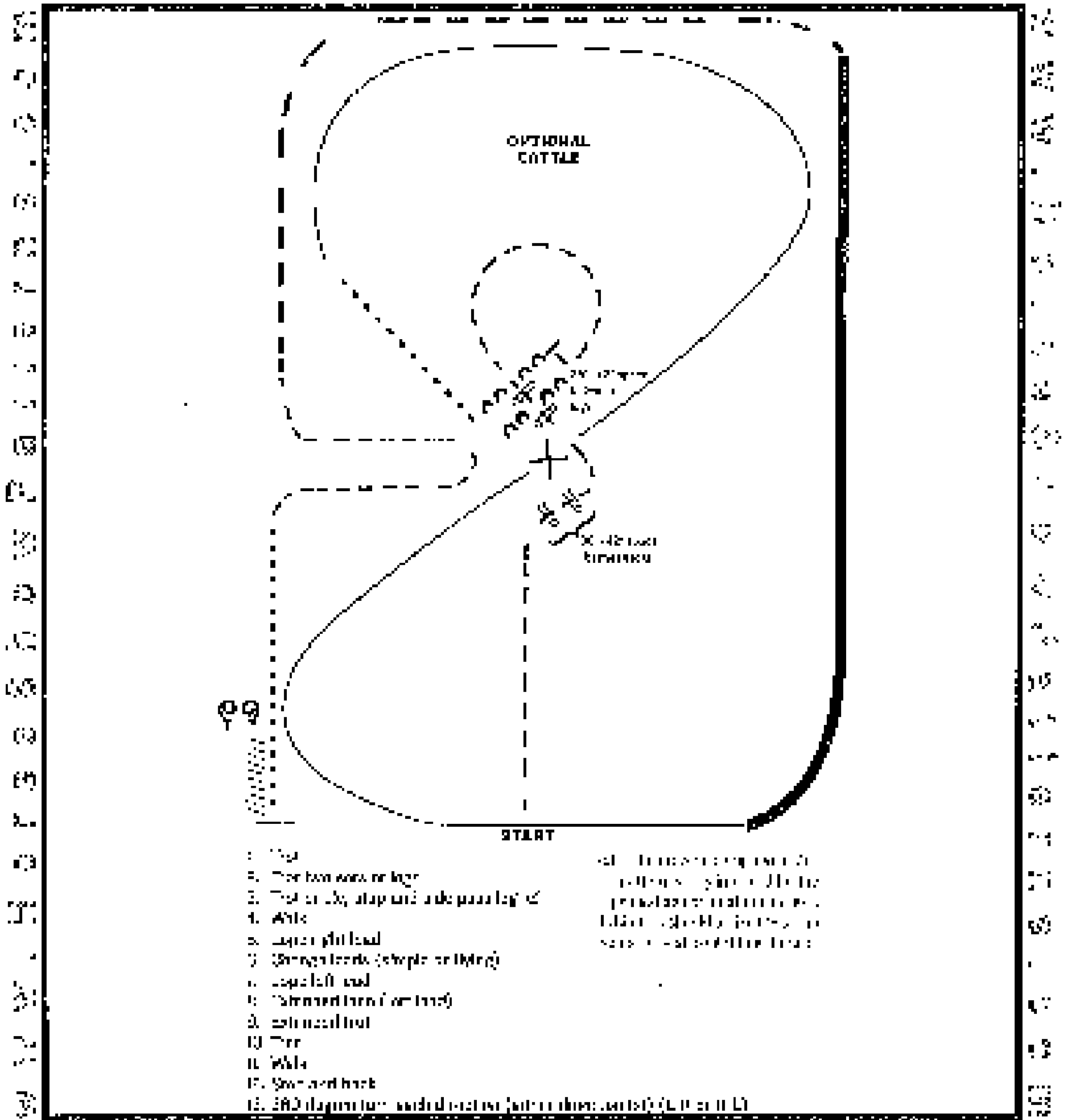

- |   |   |
|---|---|
| 1. Stop   | 16. Turn on hindquarters (L or R)                                 |
| 2. Trot two ways on legs  | 17. Trot on 3/4 step and side pass leg 4                          |
| 3. Trot on 3/4 step and side pass leg 4                           | 18. Side  |
| 4. Side   | 19. Square pit lead   |
| 5. Square pit lead  | 20. Strong leads (steple or flying)                               |
| 6. Strong leads (steple or flying)                                | 21. Square lead   |
| 7. Square lead  | 22. Slotted lead (on track)                                       |
| 8. Slotted lead (on track)  | 23. Slotted lead  |
| 9. Slotted lead   | 24. Trot  |
| 10. Trot  | 25. Side  |
| 11. Side  | 26. Square and back   |
| 12. Square and back   | 27. 360 diameter (solid and dashed) (other lines, units) (L or R) |
| 13. 360 diameter (solid and dashed) (other lines, units) (L or R) | 28. Turn on hindquarters (L or R)                                 |
|   | 29. Trot on 3/4 step and side pass leg 4                          |
|   | 30. Side  |
|   | 31. Square pit lead   |
|   | 32. Strong leads (steple or flying)                               |
|   | 33. Square lead   |
|   | 34. Slotted lead (on track)                                       |
|   | 35. Slotted lead  |
|   | 36. Trot  |
|   | 37. Side  |
|   | 38. Square and back   |
|   | 39. 360 diameter (solid and dashed) (other lines, units) (L or R) |

[RR/MQHA-9]

Pattern Provided by:  
*Johanna Vorraber*

©2024 American Paint Horse Association. All Rights Reserved.

# STYRIAN PAINT HORSE CLASSIC 2024

\*121+122\* ReRiding (all breed Rookie & Youth)

Show Dates: 07-25-07-28 2024

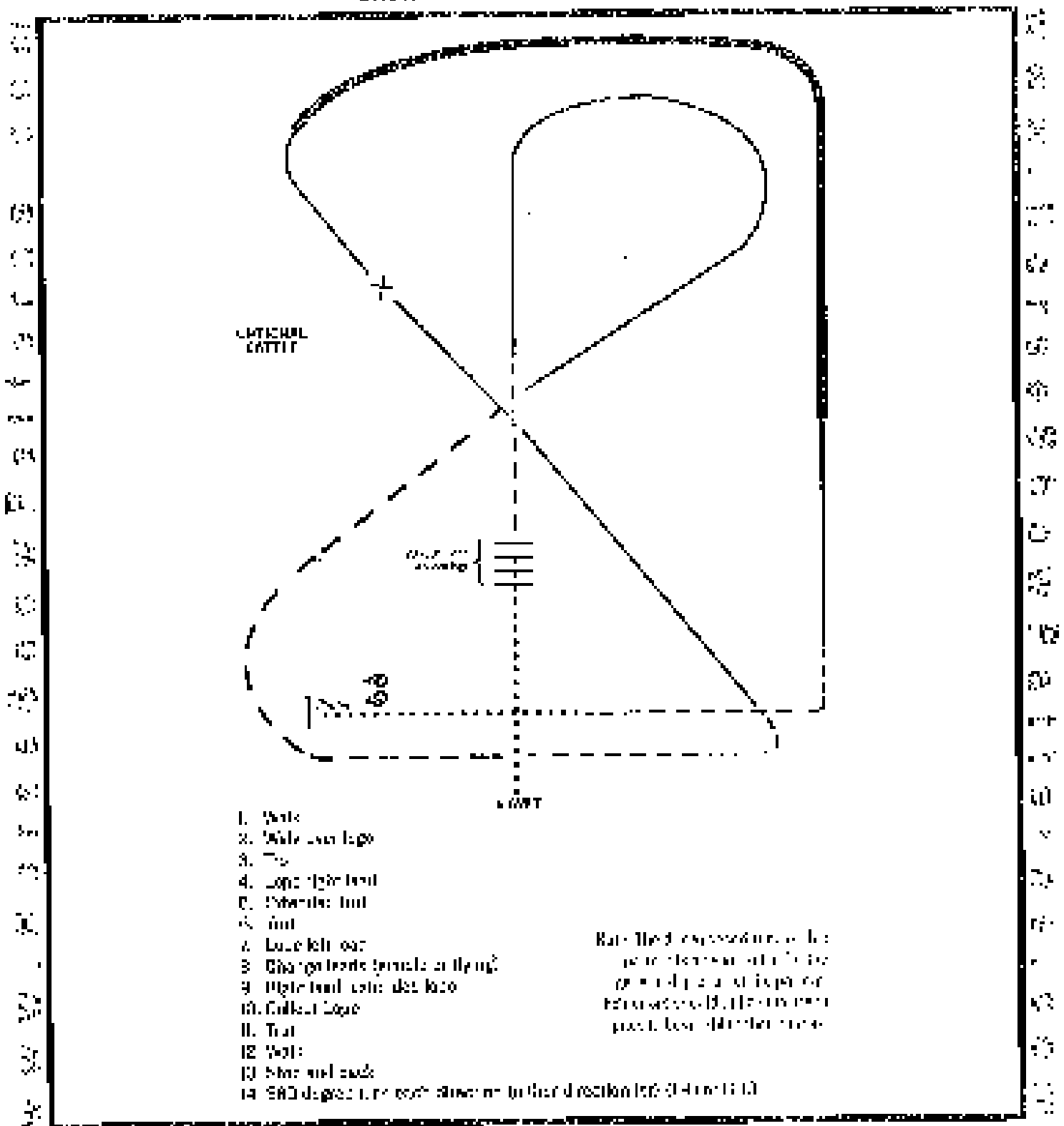

1. Walk
2. Walk over legs
3. Trot
4. Long step lead
5. Extended lead
6. Halt
7. Loose left ear
8. Change leads (inside or flying)
9. High lead, canis dist. lead
10. Collected Lead
11. Trot
12. Walk
13. Stop and back
14. 90 degree turn each direction in their direction (to 3/4 and 1/4)

Rate the dressage and the  
 performance of the  
 pattern and the  
 performance of the  
 pattern and the  
 performance of the

[RR1AQA-4]

Pattern Provided by:  
*Johanna Vorraber*

© 2024 Styrian Paint Horse Association

# STYRIAN PAINT HORSE CLASSIC 2024

## \*123+124\* Reining 5 (Amateur)

Show Date: 07-25-07-28 2024

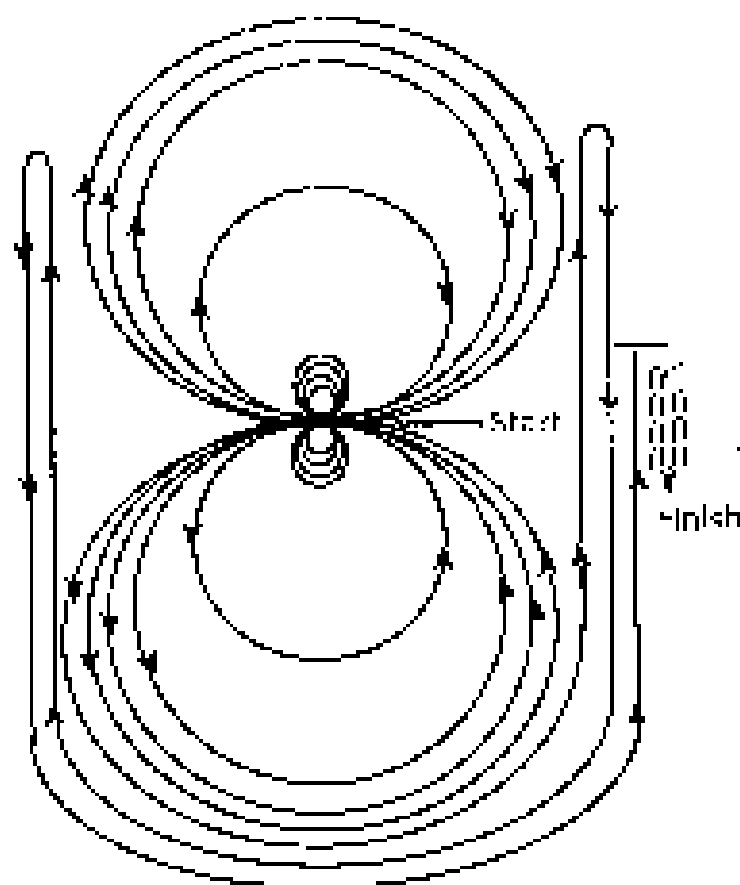

- Here are my water set out to the center of the arena. Beginning at the center of the arena being the left wall or fence
1. Beginning on the left lead, complete three circles to the left the first two circles large and two the third circle small and slow stop at the center of the arena
  2. Complete two circles to the left. Heiber
  3. Beginning on the right lead, complete three circles to the right. First two circles large and first the third circle small and slow stop at the center of the arena
  4. Complete three circles to the right. Heiber
  5. Beginning on the left lead, complete two circles to the left, through leads at the center of the arena run a large last circle to the right, and stop at the center of the arena.
  6. Complete three circles to the left, but do not close the circle. Turn up the right side of the arena past the center marker and two right circles. Turn away last circle from the wall or fence.
  7. Heiber
  8. Use the second previous circle for the next pass. This circle start on the left side of the arena past the center marker and a left rollback or less twenty feet (6.0m) from the wall or fence. Heiber
  9. Complete two circles previous circle for the next pass. This circle start on the right side of the arena past the center marker and do a sliding stop at least twenty feet (6.0m) from the wall or fence. Heiber
  10. At least ten feet (3m) from the center of the arena.
  11. Do a final stop and a final circle to the center of the arena.

[RNRHAP-5]

Pattern Provided by:

*Johanna Vorraber*

©2024 National Paint Horse Association



# STYRIAN PAINT HORSE CLASSIC 2024

25+126+127+128+130<sup>h</sup> Reining (allbreed+APHA A, NA, Y, NY, Y+NY+N

Show Date: 07-25-07-26 2024

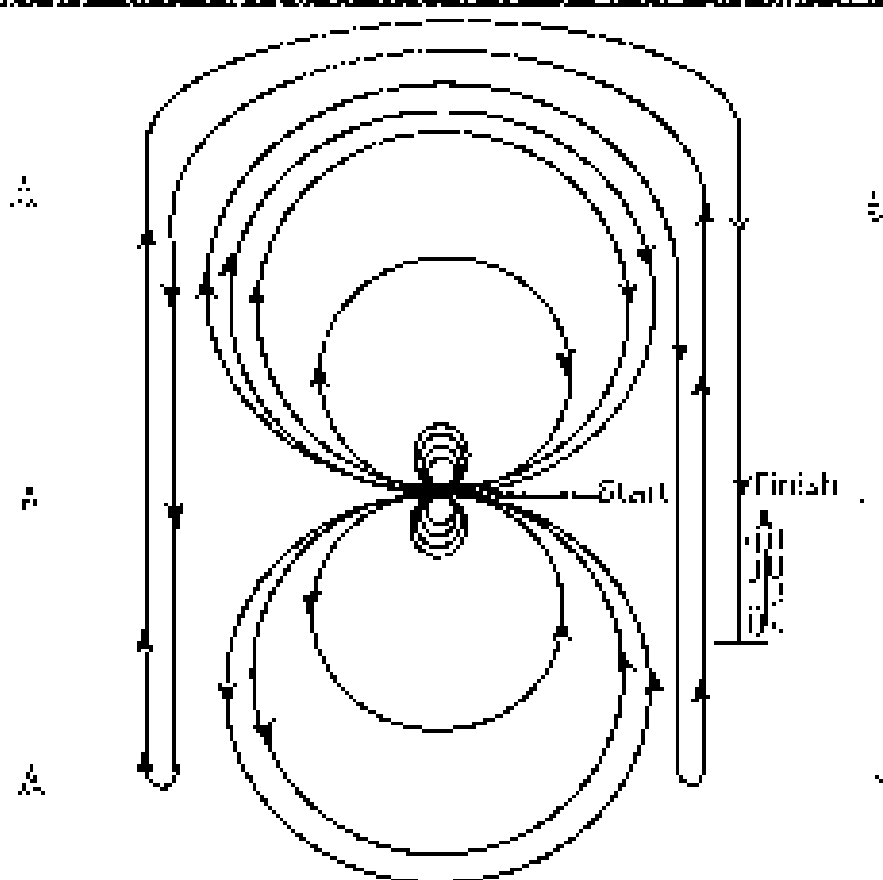

Horses may walk or trot to the center of the arena. Beginning at the center of the arena facing the left wall to finish.

1. Complete first circle to the right.

2. Complete first circle to the right. Hesitate.

3. Beginning on the right lead, complete three circles to the right: the first circle large and fast, the second medium and slow, the third small and fast. Change leads at the center of the arena.

4. Complete three circles to the left: the first circle large and fast, the second medium and slow, the third circle large and fast. Change leads at the center of the arena.

5. Complete a large fast circle to the right: but do not close this circle. Run straight down the right side of the arena past the center marker and don't let the hind end fall back. At least twenty feet (5000). Don't let the wall or knee.

6. Continue on to the left around the previous circle but do not close this circle. Run down the left side of the arena past the center marker and don't let the hind end fall back at least twenty feet (5000). Don't let the wall or knee.

7. Continue on to the right around the previous circle but do not close this circle. Run down the right side of the arena past the center marker and don't let the hind end fall back at least twenty feet (5000) from the wall or fence. Back up at least ten feet (3000). Then do a back and forth, complete all the patterns.

Rider may dismount and dismount to the designated judge.

[RNRHAP-8]

Pattern Provided by:

*Johanna Vorraber*

©2024 by the American Paint Horse Association

# STYRIAN PAINT HORSE CLASSIC 2024

Show Date: 07-25-07-28 2024

129 Kookin allbreed

Pattern L3

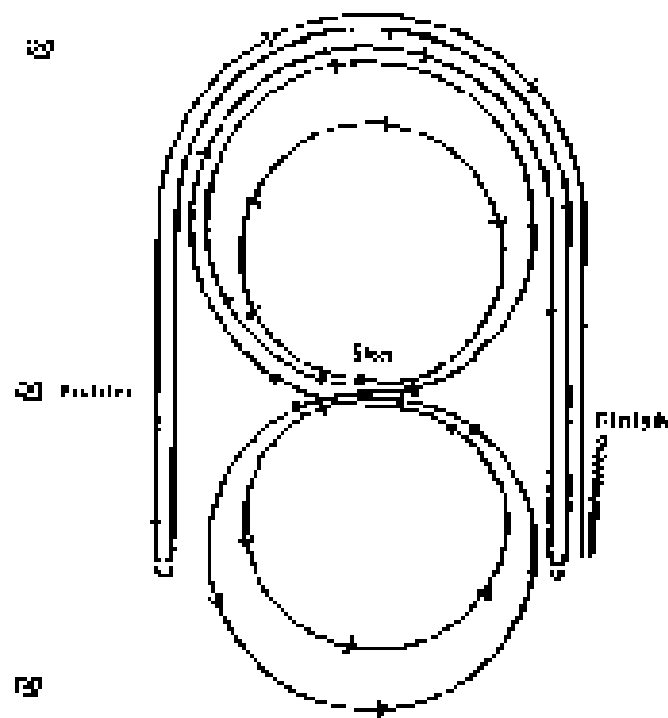

1. Start in Center Circle, zur linken Hand 2 Zählritze laufs rechts, Centrum bewegen über Richtung ab und schrittweise einwärts, bis der der Gasse wechelt
2. 2 Zählritze, die Bewegung auf schrittweise wechelt und laufs, einwärts oder langwärts eingewandert
3. 1 Zählritze, schneller Schritt, nicht schließen, zum über den Mittelreiter hinaus, mindestens 2 Meter vor der Bande und zum Schritt in beide Richtungen
4. Rechts einwärts, zum über den Mittelreiter hinaus, mindestens 6 Meter vor der Bande einwärts, Schritt, Schritt, Schritt rechts
5. Drei Zählritze, darüber Mittelreiter hinaus, mindestens 6 Meter vor der Bande einwärts Schritt, Schritt, Schritt, so zum Mittelreiter einwärts zum einwärts

Zum Pattern, über den und zum Schritt ab und Schritt.

# STYRIAN PAINT HORSE CLASSIC 2024

Show Dates: 07-25-07-28 2024

131 Amateur allbreed

166 Youth allbreed

Pattern L2

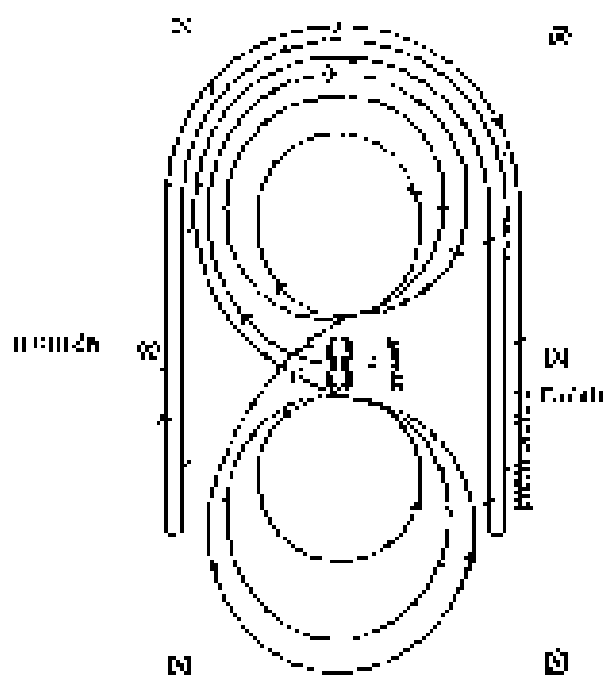

1. Im Sand zum Circle um, 300, 100 bis 150 bis 2 bis 100 Meter
2. 200 bis 100 bis 100 Meter
3. 200 bis 100 bis 100 Meter, 100 bis 100 bis 100 Meter, 100 bis 100 bis 100 Meter, 100 bis 100 bis 100 Meter
4. 200 bis 100 bis 100 Meter, 100 bis 100 bis 100 Meter, 100 bis 100 bis 100 Meter, 100 bis 100 bis 100 Meter
5. 200 bis 100 bis 100 Meter, 100 bis 100 bis 100 Meter, 100 bis 100 bis 100 Meter, 100 bis 100 bis 100 Meter
6. 200 bis 100 bis 100 Meter, 100 bis 100 bis 100 Meter, 100 bis 100 bis 100 Meter, 100 bis 100 bis 100 Meter
7. 200 bis 100 bis 100 Meter, 100 bis 100 bis 100 Meter, 100 bis 100 bis 100 Meter, 100 bis 100 bis 100 Meter

Zur Hilfe, folgen die Zeichnung Anzeichen

# STYLISH PAINT HORSE CLASSIC 2024

Show Date: 07-25-07-28 2024

132 Amateur allbreed Jun. horse

Pollam LE

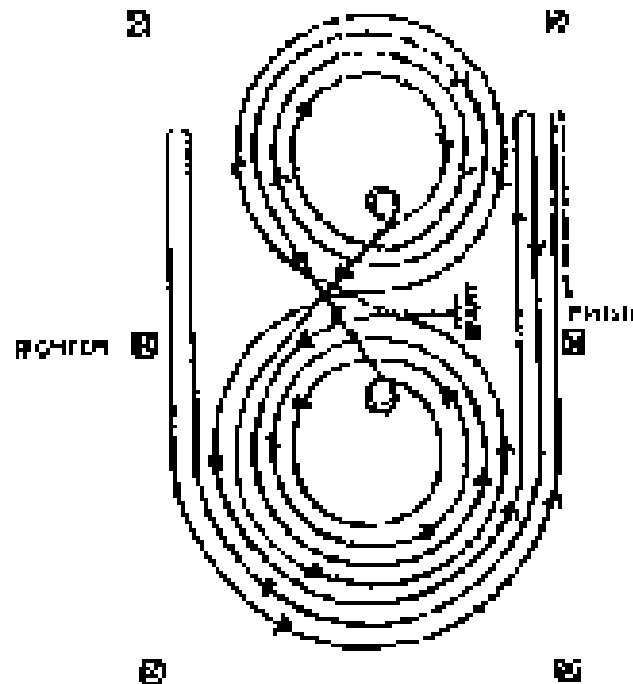

Ploten de naam of B&B of de naam van de Show in het kopje op, de naam moet overeen komen met het op de kaart en de naam van de Show in het kopje op de kaart.

1. De Show moet worden...
2. De Show moet worden...
3. De Show moet worden...
4. De Show moet worden...
5. De Show moet worden...
6. De Show moet worden...
7. De Show moet worden...
8. De Show moet worden...

De Show moet worden...

# STYRIAN PAINT HORSE CLASSIC 2024

## \*133 Reining \$ Open (all breed)

Show Dates: 07-25-07-28 2024

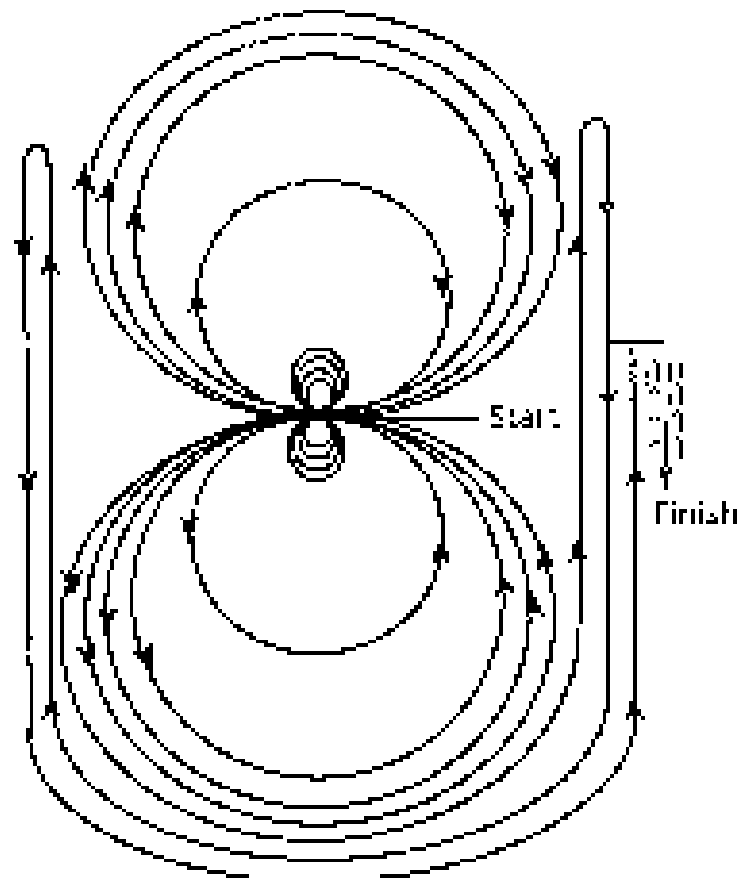

1. Beginning on the left lead, complete three circles to the left of the center circle's path. The first circle should end square to the center of the arena.
2. Complete two circles to the left. Then:
3. Beginning on the right lead, complete two circles to the right. The first two circles larger than the third circle. Small gap show stop at the center of the arena.
4. Complete two circles to the right. Then:
5. Beginning on the left lead, complete two circles to the left. Charge leads on the center of the arena, then a large last circle on the right, an "empty lead" at the center of the arena.
6. Complete two small circles to the left. Then an "empty lead" on the right side of the arena. Then go to the center circle and the right side back to the center. Two (200) ft from the wall or fence no hes turns.
7. Complete two small circles to the left. Then charge leads. Run up the left side of the arena near the corner and back and the left wall for at least twenty feet (200) ft. Then the right side of the arena.
8. Complete back to small circles to the right. Then charge leads. Run up the right side of the arena near the corner and the right wall for at least twenty feet (200) ft. Then the left side of the arena.
9. Complete two small circles to the left. Then an "empty lead" on the right side of the arena. Then go to the center circle and the right side back to the center. Two (200) ft from the wall or fence no hes turns.

[R/NRHAP-5]

Pattern Provided by:

Johanna Vorraber

2024 Styrian Paint Horse Classic, Inc. All rights reserved.

# STYRIAN PAINT HORSE CLASSIC 2024

## \*146 Western horsemanship (Youth Rookie)

Show Dates: 07-25 07-26 2024

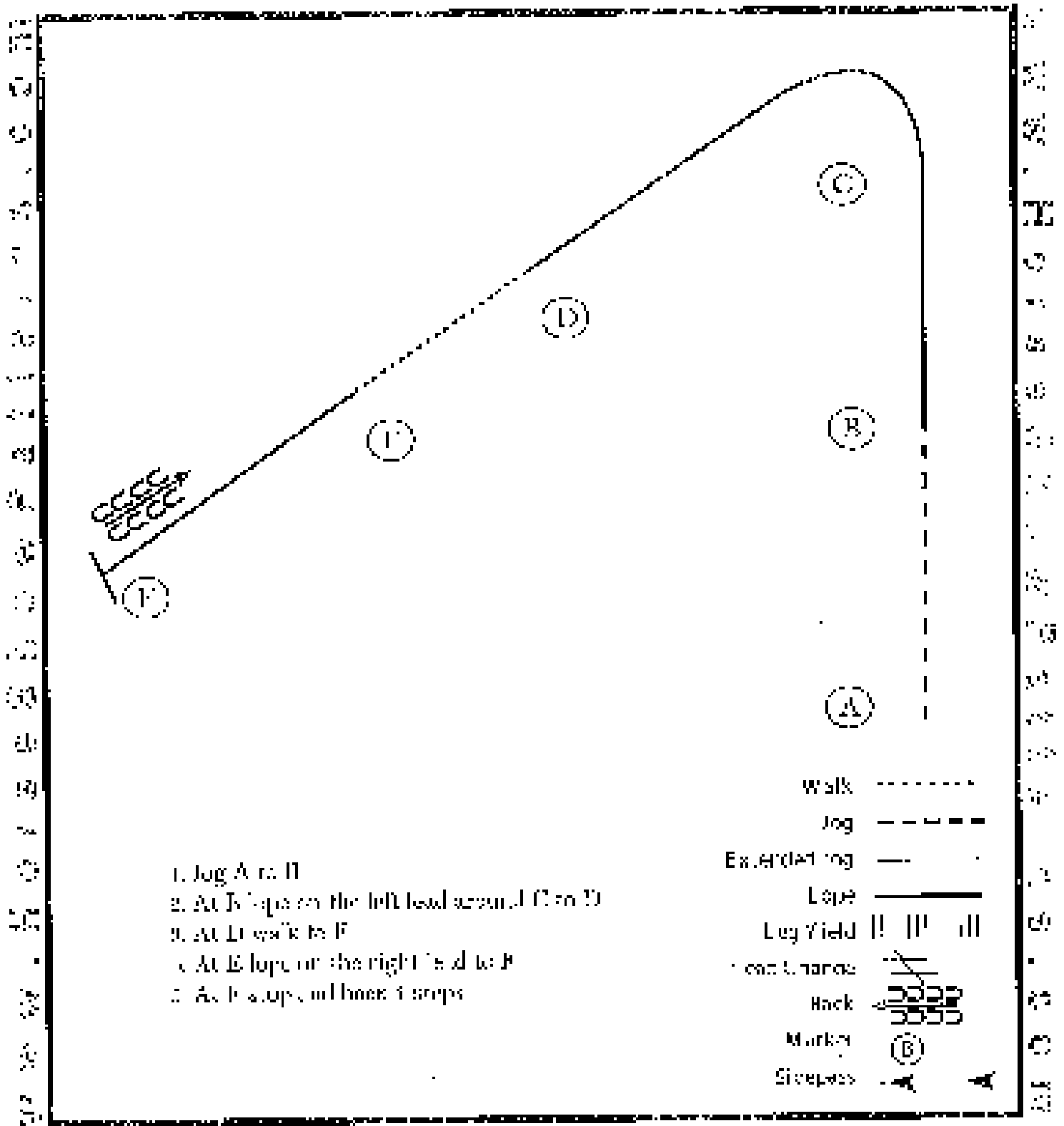

[WH4-31]

Pattern Provided by:  
*Johanna Vorraber*

Copyright © 2024 by the American Quarter Horse Association

# STYRIAN PAINT HORSE CLASSIC 2024

\*147 149 R&Riding A NA (all breed APHA NA)

Show Date: 07-25-07-28 2024

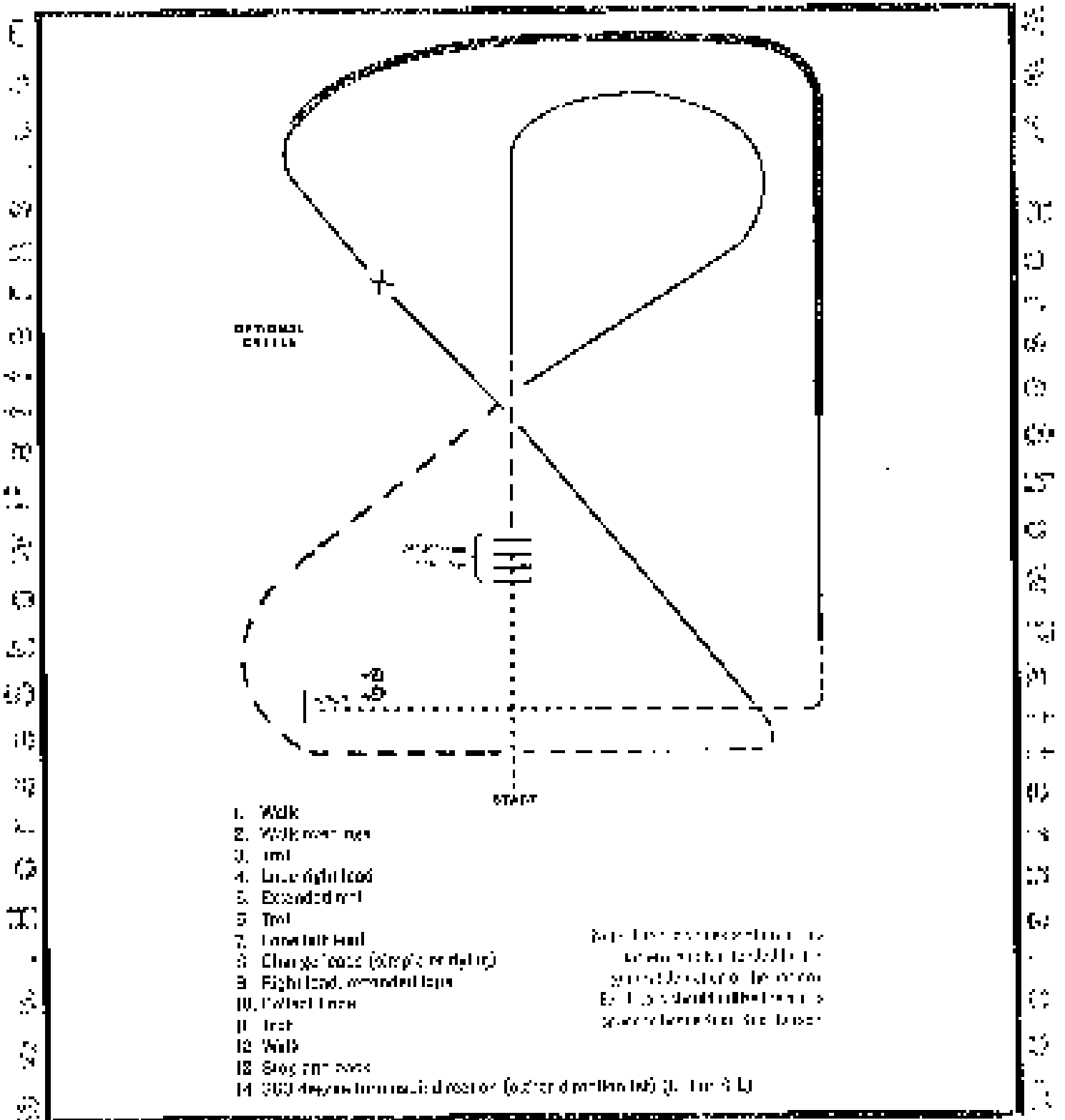

[RR/AQHA-8]

Pattern Provided by:

*Johanna Vorraber*

PO Box 1000, Rittsburg, NY 14624-1000

# STYRIAN PAINT HORSE CLASSIC 2024

## #148 Ranch Riding (allbreed Open)

Show Dates: 07-25-07-28 2024

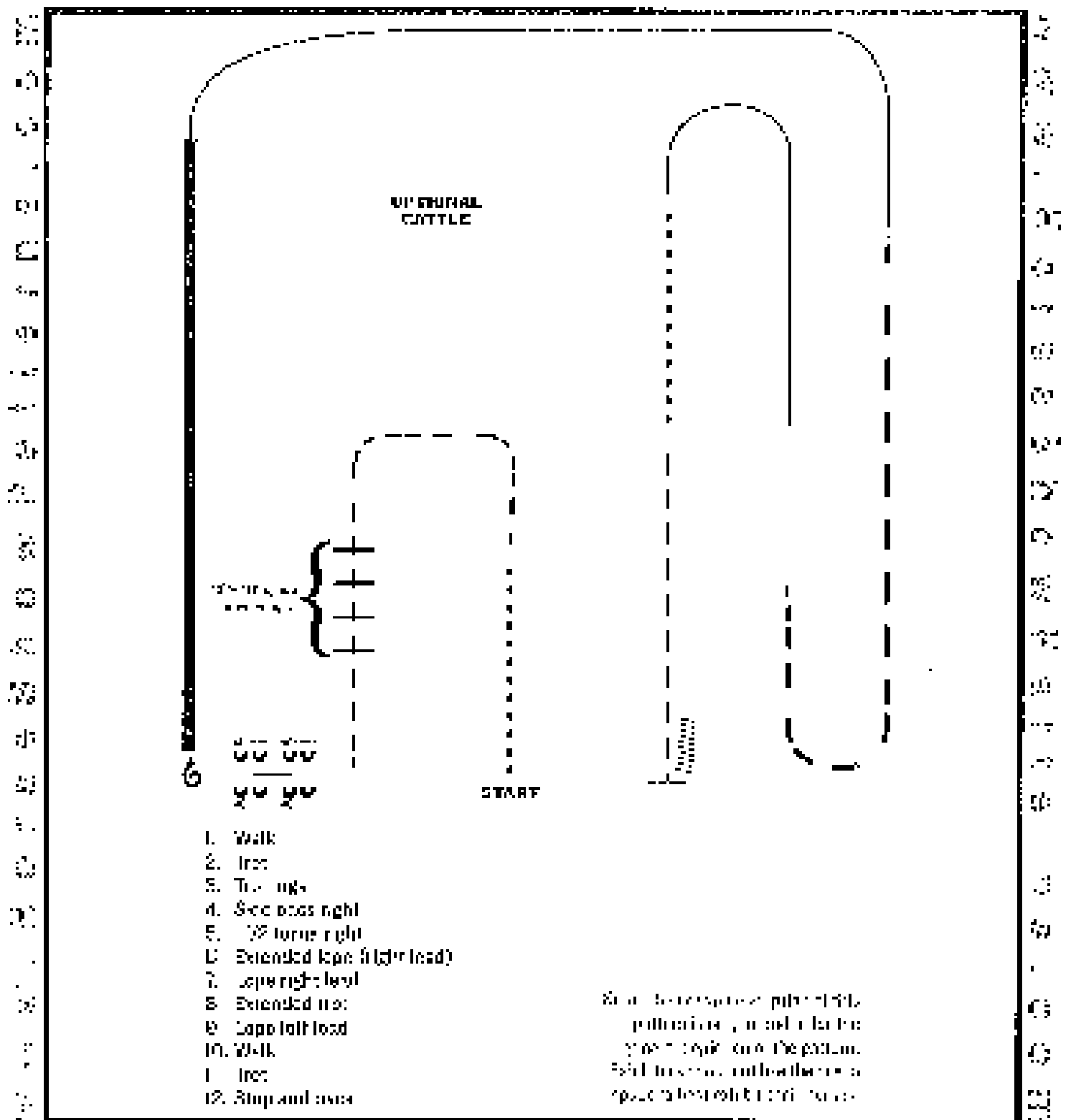

[RR/AQHA-12]

Pattern Provided by:

*Johanna Vorraber*

©2024, www.styrianpainthorse.com, All Rights Reserved



# STYRIAN PAINT HORSE CLASSIC 2024

\*157+158\* Green Western Riding (SFB + regular)

Show Dates: 07-25 07-26 2024

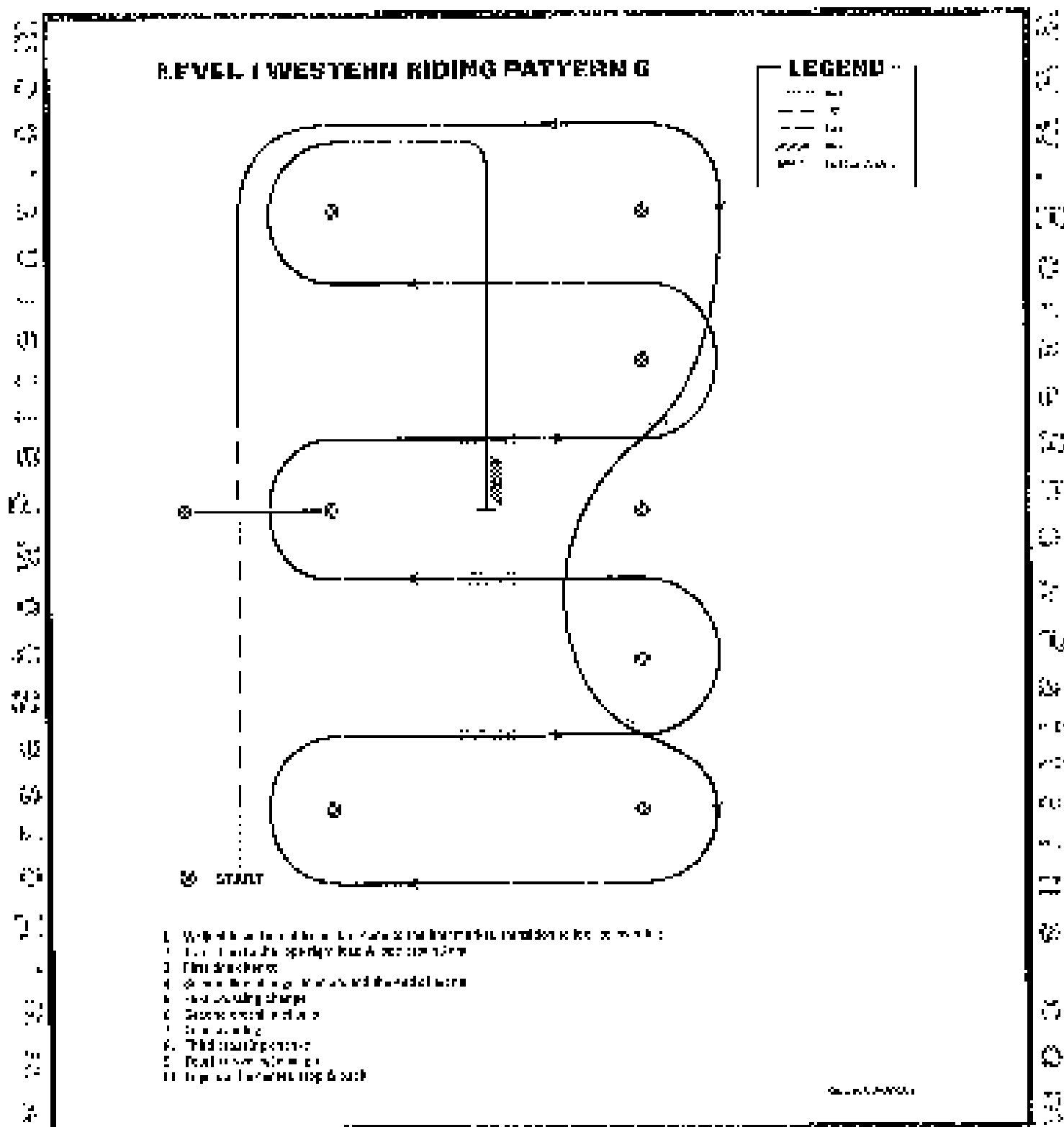

[WR/GP-6]

Pattern Provided by:  
*Johanna Vorraber*

© 2024 Western Paint Horse Association, All Rights Reserved

# STYRIAN PAINT HORSE CLASSIC 2024

\*159+160+161\* WR Open (Allbreed, SPB + Regular)

Show Dates: 07-25-07-28 2024

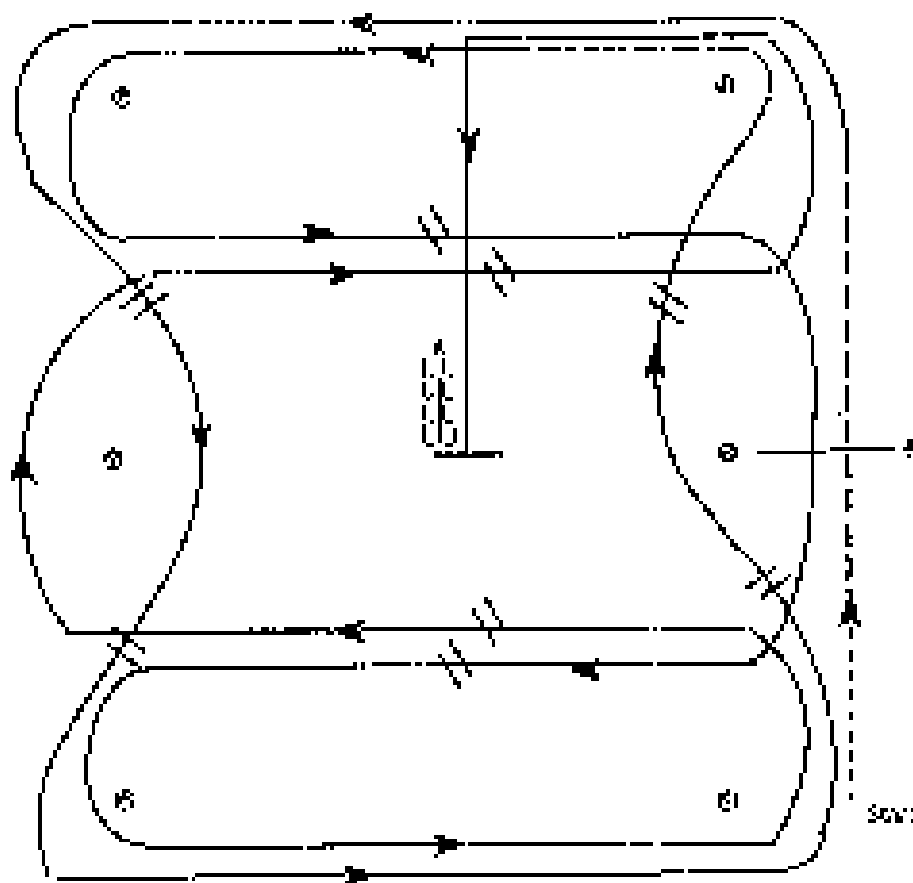

1. Walk, transition to jog, jog over top
2. Transition to the lope, on the left lead.
3. First line change.
4. Second line change.
5. Third line change.
6. Fourth line change.
7. First crossing change.
8. Lope over the top.
9. Second crossing change.
10. Third crossing change.
11. Fourth crossing change.
12. Lope, stop and back.

[WRICP-5]

Pattern Provided by:

*Johanna Vorraber*

©2024 World Show Events, Inc. All Rights Reserved.

# STYRIAN PAINT HORSE CLASSIC 2024

162-163\* WHMS Amateur (NAPHA regular + SPB)

Show Date: 07-25-07-28 2024

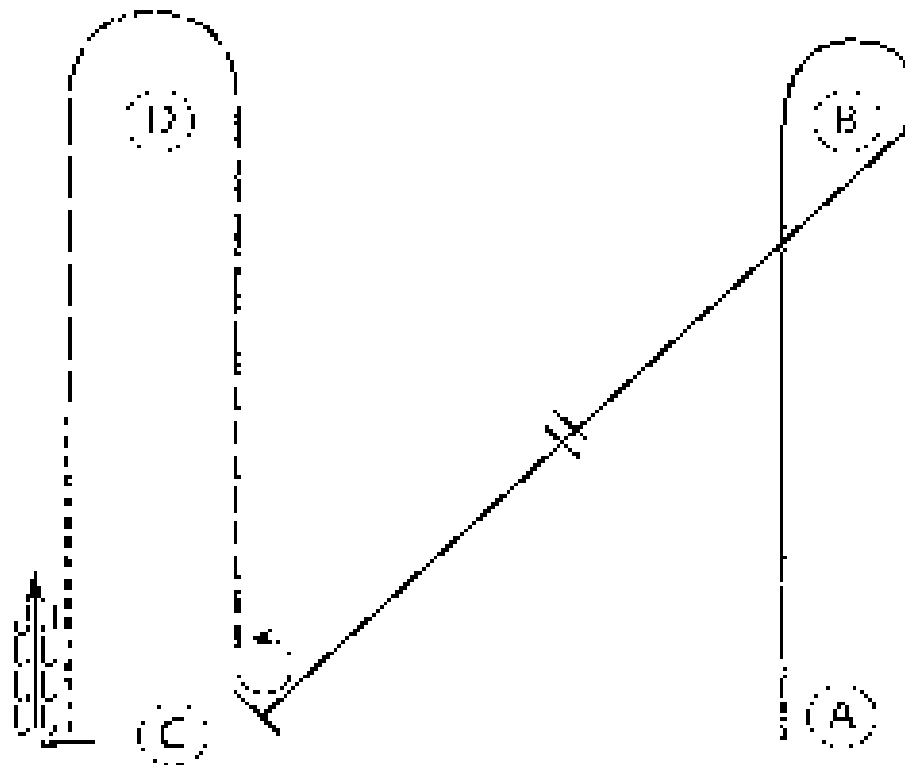

Be ready at A

1. Lope on the right lead from A to and around B.
2. Halfway to C, perform a flying lead change.
3. Lope to C.
4. Stop and perform a 270 degree turn to the left.
5. Jog halfway to D.
6. Extend the jog to and around D.
7. Halfway to C, break to a walk.
8. Stop at C and back approximately one horse length.

Follow the instructions of your ring steward

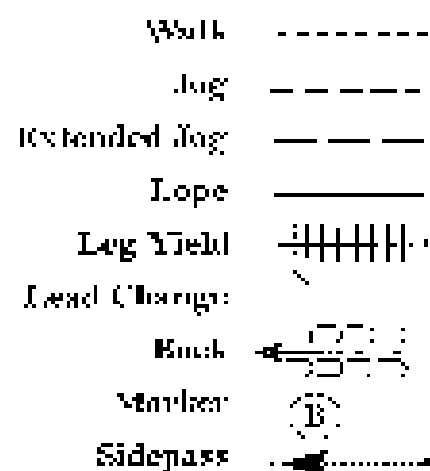

[WH03-71]

Pattern Provided by:

*Johanna Vorraber*

© 2011, reprinted with permission of the author

# STYRIAN PAINT HORSE CLASSIC 2024

## #164 Reining Opwn (allbreed)

Show Date: 07-25-07-26 2024

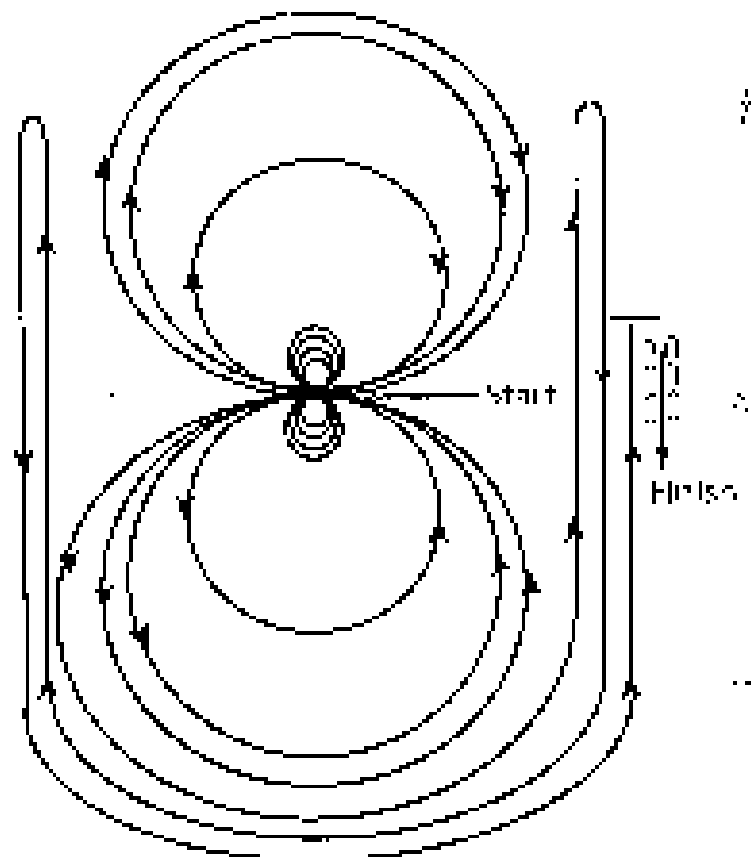

How to lay with a trot to the center of the arena. Beginning at the center of the arena facing the left wall or fence.

1. Complete four spins to the right.
  2. Complete four spins on the left. Hesitate.
  3. Begin by going in left lead, complete three circles on the left: the first one circles large and first in third of arena small and slow. Change to trot at the center of the arena.
  4. Complete three circles to the right: the first one circles large and fast; the first circle small and slow. Change leads at the center of the arena.
  5. Begin by going in right lead to the left but do not do a circle. Step up the right side of the arena past the center marker and do a right wallman of least twenty feet (6.10m) from the wall or fence – no hesitation.
  6. Continue back around previous circle but do not do a circle. Turn to the left side of the arena past the center marker and do a left wallman at least twenty feet (6.10m) from the wall or fence – no hesitation.
  7. Continue back around previous circle but do not do a circle. Step up the right side of the arena past the center marker and do a sliding stop at least twenty feet (6.10m) from the wall or fence. Do not do at least ten feet (3m). Hesitate to demonstrate the completion of the pattern.
- Rider may dismount and drop handle on the designated judge.

[RNRHAP-6]

Pattern Provided by:

*Johanna Vorraber*

©2024, Styrian Paint Horse Classic, All Rights Reserved

# STYRIAN PAINT HORSE CLASSIC 2024

\*165 Rining jurL Open (allbreed)

Show Date: 07-25-07-29 2024

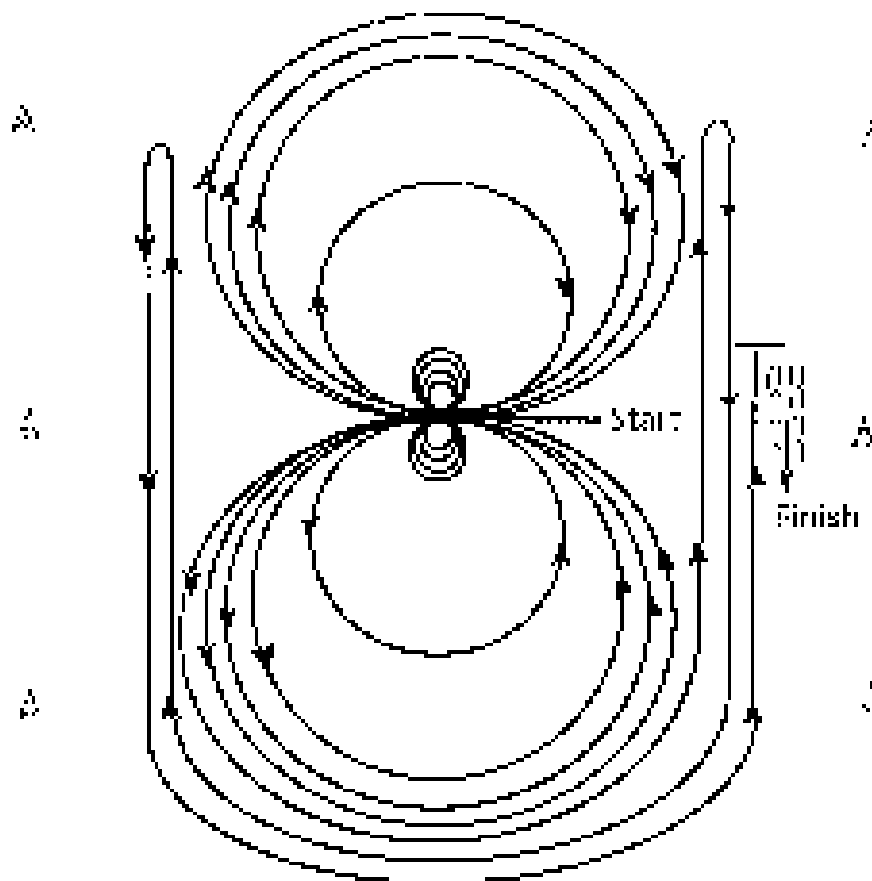

1. Walk or trot to the center of the arena beginning at the center of the arena facing the left wall or fence beginning on the left hand complete four circles to the left, the first two circles large and fast, the third circle small and slow. Stop at the center of the arena.

2. Complete four circles to the left. Heats:

a. Beginning on the right hand, complete four circles to the right. The first two circles large and fast, the third circle small and slow. Stop at the center of the arena.

b. Complete four circles to the right. Heats:

a. Beginning on the left hand, make a large fast circle to the left, the size depends on the center of the arena. Then a large fast circle to the right, and change hands at the center of the arena.

b. Complete around previous circle to the left but do not close this circle. Turn on the right side of the arena past the center marker and close right circle at least once by line (20m) from the wall or fence - no rotation.

c. Complete around previous circle but do not close this circle. Turn on the left side of the arena past the center marker and close left circle at least once by line (20m) from the wall or fence - no rotation.

d. Complete around previous circle but do not close this circle. Turn on the right side of the arena past the center marker and close right circle at least once by line (20m) from the wall or fence - no rotation.

3. Walk or trot to the center of the arena.

[RNRHAP-5]

Pattern Provided by:

*Johanna Vorraber*

© 2024 Vorraber & Partners, LLC. All Rights Reserved.

# STYRIAN PAINT HORSE CLASSIC 2024

Show Date: 07-25-07-28 2024 \*171\* Ranch Trail Rode allbreed

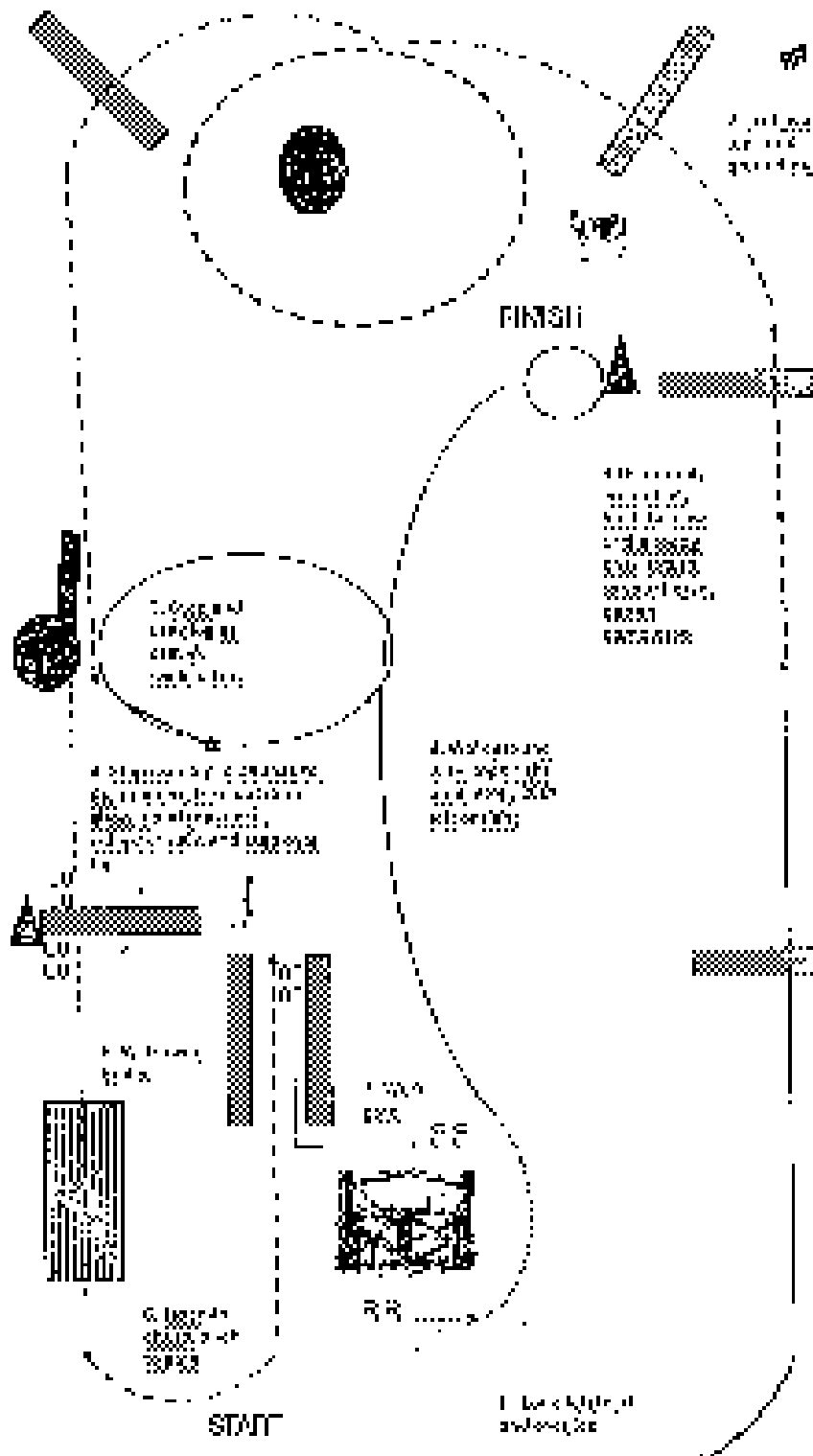

# STYRIAN PAINT HORSE CLASSIC 2024

Show Date: 07-25-07-28 2024 \*172\* Ranch Trail Open allbreed

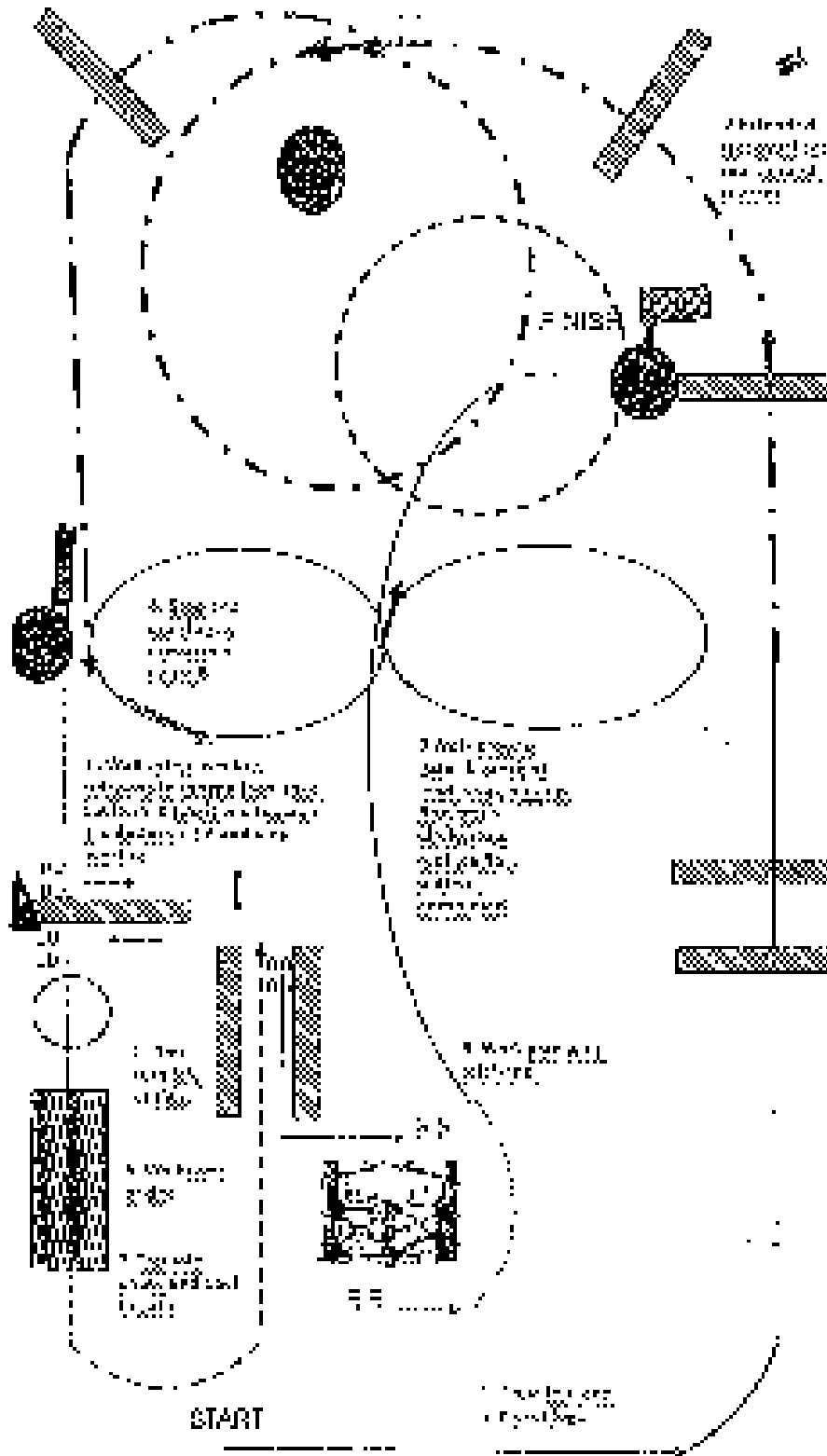

# STYRIAN PAINT HORSE CLASSIC 2024

\*179+180 Reining APHA (Open SPB + regular)

Show Date: 07-25 07 28 2024

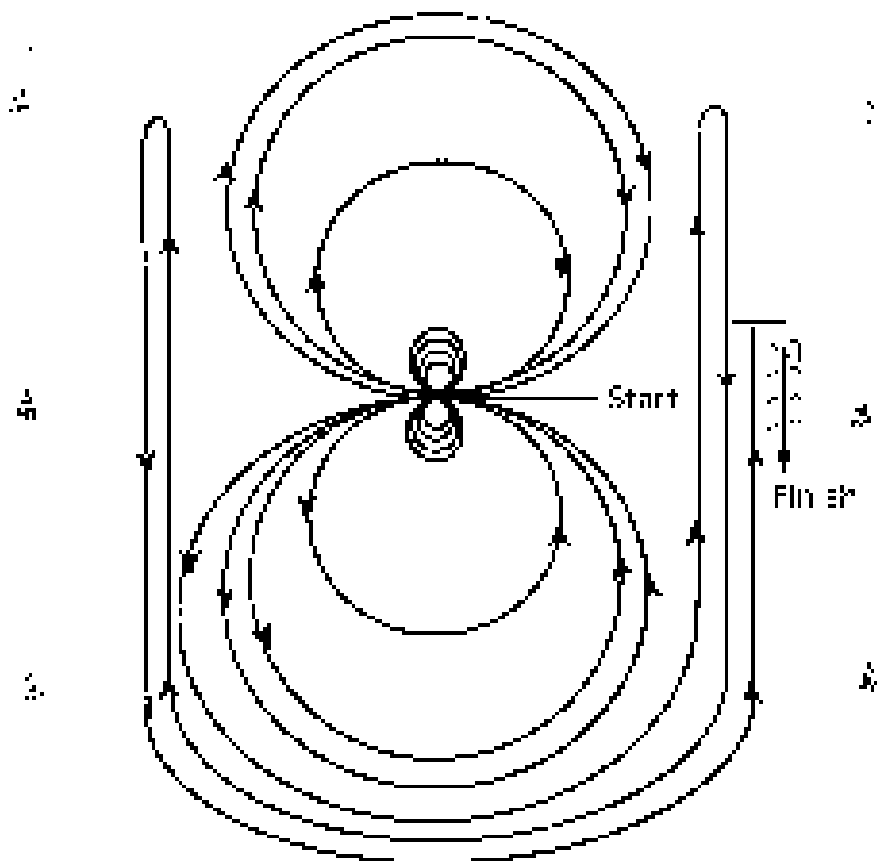

Horses may walk or trot to the center of the arena. Beginning at the center of the arena, begin the left wall or fence.

1. Complete four spins to the right.

2. Complete four spins to the left. First is a:

a. Beginning on the left lead, complete three circles to the left: the first two circles large and fast, the third circle small and slow. Change leads at the center of the arena.

b. Complete three circles to the right: the first two circles large and fast, the third circle small and slow. Change leads at the center of the arena.

3. Beginning on the left lead, circle to the left but do not close this circle. Back up the right side of the arena past the center marker and the right side of each circle at least twenty (20) feet from the wall or fence. See illustration.

4. Continue three around previous circles but do not close this circle. Back up the left side of the arena past the center marker and the left side of each circle at least twenty (20) feet from the wall or fence. See illustration.

5. Continue three around previous circles but do not close this circle. Back up the right side of the arena past the center marker and the right side of each circle at least twenty (20) feet from the wall or fence. Back up at least ten (10) feet to demonstrate the completion of the pattern.

Refer to the diagram for the exact location for the completion of the pattern.

[RINRHAP-6]

Pattern Provided by:

*Johanna Vorraber*

©2024 American Quarter Horse Association, APHA, AQHA, AQHA



# STYRIAN PAINT HORSE CLASSIC 2024

## \*183+184 Reining (allbreed Open + Youth LM)

Show Dates: 07-25-07-28/2024

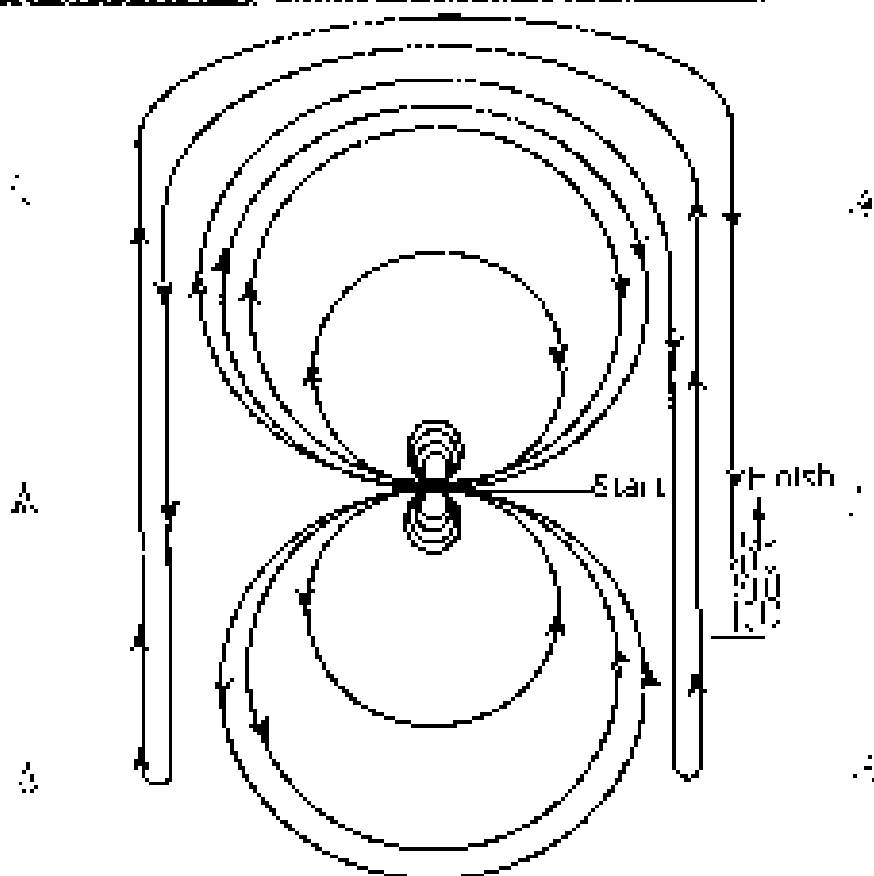

Horses may not cross the boundaries of the arena. Beginning at the center of the arena facing the left wall of the arena:

1. Complete four spirals to the left.
2. Complete four spirals to the right. Execute.
3. Beginning on the right line, complete three circles to the right: the first circle large and fast; the second circle small and slow; the third circle large and fast. Change leads at the center of the arena.
4. Complete three circles to the left: the first circle large and fast; the second circle small and slow; the third circle large and fast. Change leads at the center of the arena.
5. Begin a long sliding stop to the right, at least slow to a walk. Turn straight away to the right side of the arena past the center marker and do a tight roll back at least twenty feet (6.09m) from the wall of the arena to the center.
6. Continue back around the previous circle and do three fast circles. Then cross the left side of the arena past the center marker and do a tight roll back at least twenty feet (6.09m) from the wall of the arena to the center.
7. Continue back around the previous circle and do two close flying circles. Run down the right side of the arena past the center marker and do a sliding stop at least twenty feet (6.09m) from the wall of the arena. Back up at least ten feet (3.05m) then do a dismount and complete all the designated circles.

(R/N/RHAP-8)

Pattern Provided by:

*Johanna Vorraber*

©2024 Styrian Paint Horse Association, Inc.

# STYRIAN PAINT HORSE CLASSIC 2024

\*185+186 ReRiding allbreed (Open + LM Youth)

Show Date: 07-29-07-26 2024

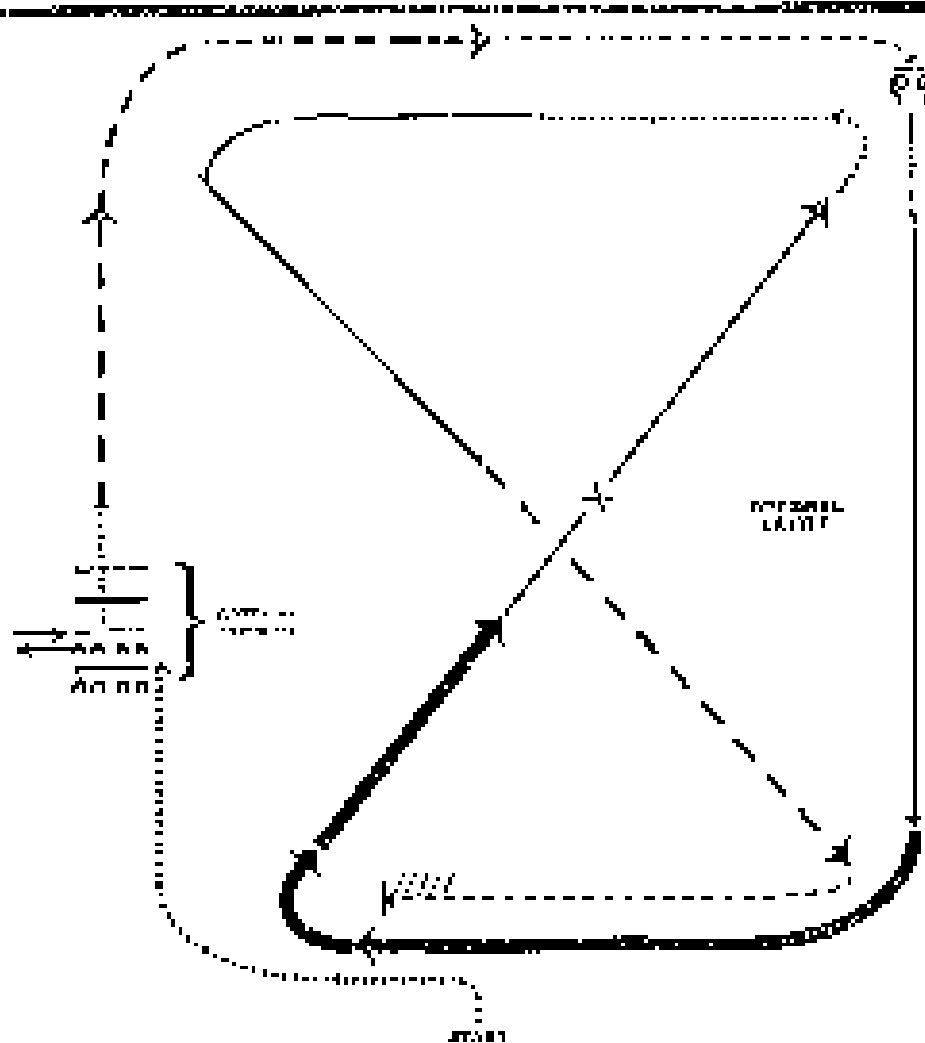

1. Walk
2. Side pass left corner (or right side pass 1/2 way to right)
3. Walk across edge
4. Extended trot
5. Trot
6. Stop, 90 degree turn each direction (either direction) (L-R or R-L)
7. Lope right lead
8. Extended line (right lead)
9. 3/4 or 1/2 lope, change leads (simple or flying)
10. Walk
11. Lope left lead
12. Extended trot
13. Trot
14. Stop and back

Start in the lead you prefer  
 if the pattern is to be done  
 the first way is to be done  
 the first way is to be done  
 the first way is to be done  
 the first way is to be done

[RR/AQHA-S]

Pattern Provided by:

*Johanna Vorraber*

# STYRIAN PAINT HORSE CLASSIC 2024

## \*187 Riding Ranch Horse Challenge (Open allbreed)

Show Date: 07 25 07 28 2024

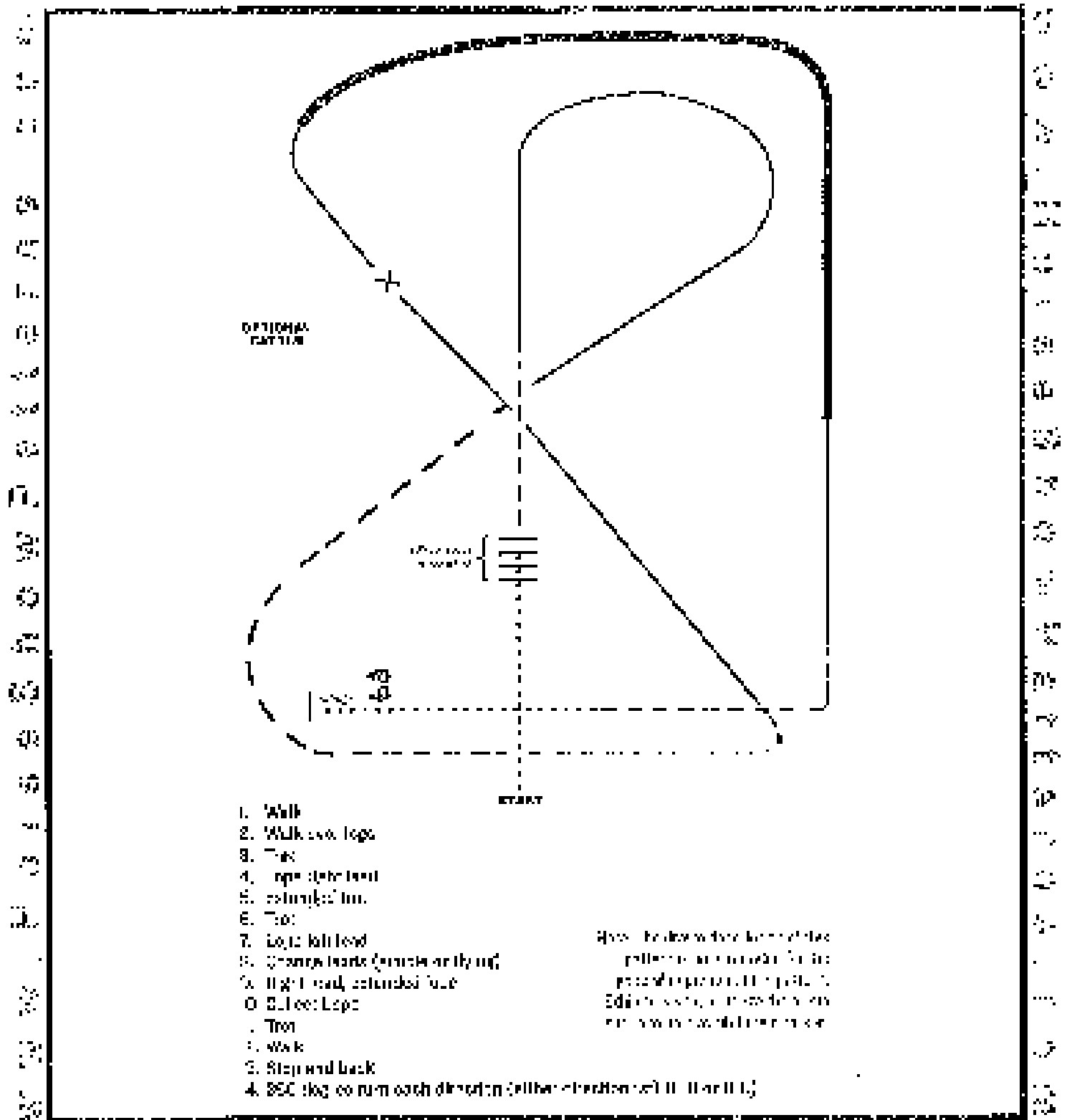

[RR/AQHA-5]

Pattern Provided by:

*Johanna Vorraber*

©2024 Johanna Vorraber, www.AustrianPaint.com

# STYRIAN PAINT HORSE CLASSIC 2024

## \*188 Futurity Reining (APHA Open)

Show Date: 07-26-07-28 2024

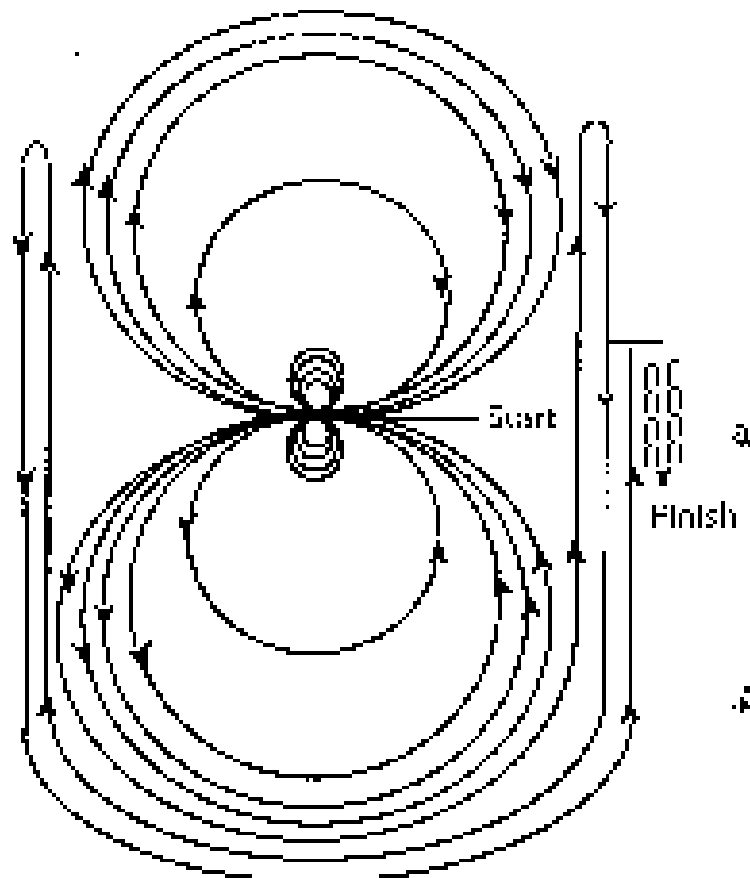

- Then set away with a lead to the center of the arena. Beginning at the center of the arena slide up the left wall for 5000.
1. Beginning on the left wall, complete three circles to the left. The first two circles large and close to the inside wall and close together on the center of the arena.
  2. Complete turning in to the left. Heel in.
  3. Beginning on the right wall, complete three circles to the right. The last two circles large and close to the inside wall and close together on the center of the arena.
  4. Complete turning in to the right. Heel in.
  5. Beginning on the left wall, set a large first circle to the left, change wall at the center of the arena, turn a large first circle to the right, and change back on the center of the arena.
  6. Confine a small groove circle to the left, set a small close 1/2 circle. Run up the right side of the arena past the center marker and do a right necklock at least twenty feet (9000) from the wall or fence as heeled in.
  7. Confine a small groove circle and do a small close 1/2 circle. Run up the left side of the arena past the center marker and do a left necklock at least twenty feet (9000) from the wall or fence as heeled in.
  8. Confine a small groove circle and do a small close 1/2 circle. Run up the right side of the arena past the center marker and do a sliding stop at least twenty feet (9000) from the wall or fence. Heel.
  9. On the left wall (9000), Heel in to do a small close 1/2 circle at the center.
  10. Set a small groove and do a small close 1/2 circle as heeled in.

[R1NRHAP-S]

Pattern Provided by:

*Johanna Vorraber*

www.styrianpainthorse.com/2024/07/26/